

# Wind Power

## Today & Tomorrow

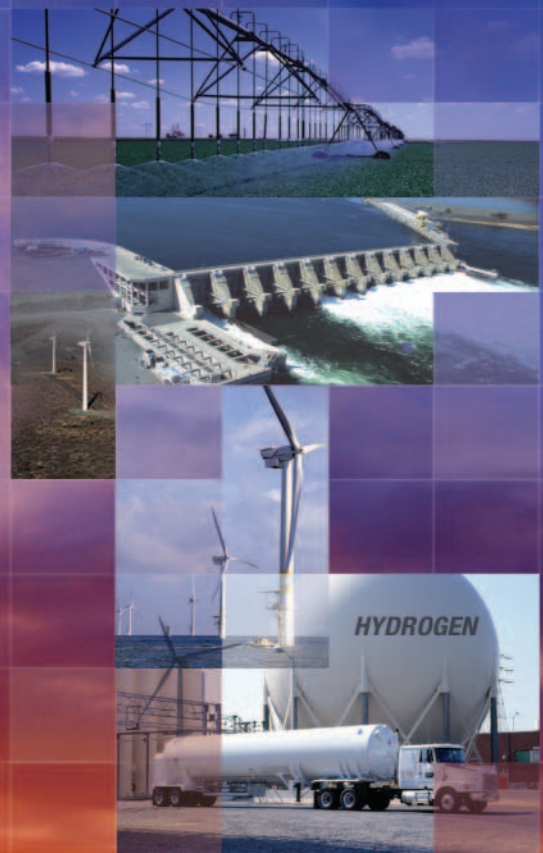

Bringing you a prosperous  
future where energy is  
clean, abundant, reliable,  
and affordable



- DOE launches Phase II Low Wind Speed Research
- Sandia teams design new hybrid blades
- NREL's new blade test cuts test time by more than 50%
- DOE initiates offshore development research



U.S. Department of Energy  
**Energy Efficiency and Renewable Energy**

**Wind and Hydropower  
Technologies Program**



**Wind & Hydropower Technologies Program —  
Harnessing America's abundant natural resources for clean power generation.**

**Contents**

**WIND POWER TODAY AND TOMORROW:  
THE ADVANCING INDUSTRY . . . . .1**

**WIND POWER TODAY: DEVELOPING NEW TERRITORIES  
WITH LOW WIND SPEED TECHNOLOGIES . . . . .4**

**WIND POWER TOMORROW: FUELING THE FUTURE WITH WIND . . . .20**

**THE FEDERAL WIND ENERGY PROGRAM . . . . .27**

**2003 Wind Energy Research Highlights**

**U.S. wind energy capacity tops 6300 MW in 2003 . . . . .2**

**DOE launches Phase II Low Wind Speed Research . . . . .5**

**New drivetrain tested at NREL reduces weight by 30% . . . . .7**

**Sandia teams design new carbon/glass fiber hybrid blades . . . . .8**

**NREL's new hydraulic resonance blade test system cuts test time by more than 50% . . . . .9**

**DOE awards \$1.5 million in grants for R&D to advance small wind turbines . . . . .11**

**WPA finalizes new wind resource maps for five additional states . . . . .13**

**First Native American wind turbine goes on line . . . . .18**

**DOE initiates research effort on offshore development . . . . .21**

**DOE sponsors IEA R&D Wind Annex XI Topical Expert Meeting on the Integration of  
Wind and Hydropower Systems . . . . .24**

Cover photo: Today, wind power plants of various size provide enough energy to meet the needs of more than 3 million homes. Innovative wind energy technologies for future applications may include offshore deepwater development, working with hydropower to provide a stable supply of electricity, the use of wind energy to clean and move water and the production of hydrogen.





# WIND POWER TODAY AND TOMORROW— The Advancing Industry

In the 1930s, Leroy Ratzlaff and his family built a small wind turbine to take advantage of the high winds that blow across the ridge where their family farm is located in Hyde County, South Dakota. The turbine produced enough electricity to power their radio. Today, the Ratzlaff farm still reaps the benefits of the wind by hosting seven 1.5-MW wind turbines. The turbines produce enough electricity to power more than 2000 homes and provide more than \$10,000 annually in additional income for the family farm. The Ratzlaffs are not alone. From the Midwest to the shores of California to the waters off the East Coast, wind farms, fed by one of this nation's cleanest and most abundant renewable resources, are taking root.

The goal of the wind energy industry is to contribute 100 GW of wind electricity to our nation's energy supply by 2020. By meeting that goal, wind energy will help secure our nation's energy future and clean up our environment by displacing about 3 quadrillion Btus of primary energy per year and 65 million metric tons of carbon equivalent per year.

In 2003, the U.S. wind generating capacity increased by more than 30%. Wind power plants of various size now operate in 32 states with a total generating capacity of 6374 MW of power, enough to meet the energy needs of more than 3 million homes. The research and development (R&D) conducted under the U.S. Department of Energy (DOE) Wind and Hydropower Technologies Program has been a key element contributing to the rapid growth of wind energy in the United States. Since the 1970s, DOE researchers and their industry partners have sought ways to produce competitive electricity with wind power, and in the past 30 years, these partnerships have reduced the cost of wind energy by more than 80%.

While wind energy technologies have come a long way—from powering farm kitchen radios to powering entire cities—researchers and industry members see this as a small fraction of a wind crop that can provide at least 6% of the nation’s electricity by 2020. The wind farms that have been built to date primarily take advantage of our country’s best wind resources (Class 6). However, our nation also enjoys an abundance of lower-wind-speed resources. Class 4 wind resources are more common and they are located closer to the load centers on land and offshore, making them easier and more economical to develop. To develop those areas and ensure continued industry growth, researchers are working to help industry develop technologies that will be profitable in low wind speed environments.

In addition to developing utility-scale technologies, the Wind Program works to increase the efficiencies of small wind systems for residential, farm, and business applications. It also works with industry stakeholders to resolve



Researchers work with industry partners to advance wind energy technologies and lower the cost of production.

issues that impede growth for both large and small wind system industries.

Innovative wind energy technologies for future applications may include offshore deepwater development and the use of wind energy to clean and move water. They are also exploring synergies between wind energy and other technologies such as hydropower and hydrogen. Future research may enable Leroy Ratzlaff’s descendants to harvest their crops with a combine fueled by hydrogen produced with power from the wind.

## 2003 U.S. Wind Capacity Map

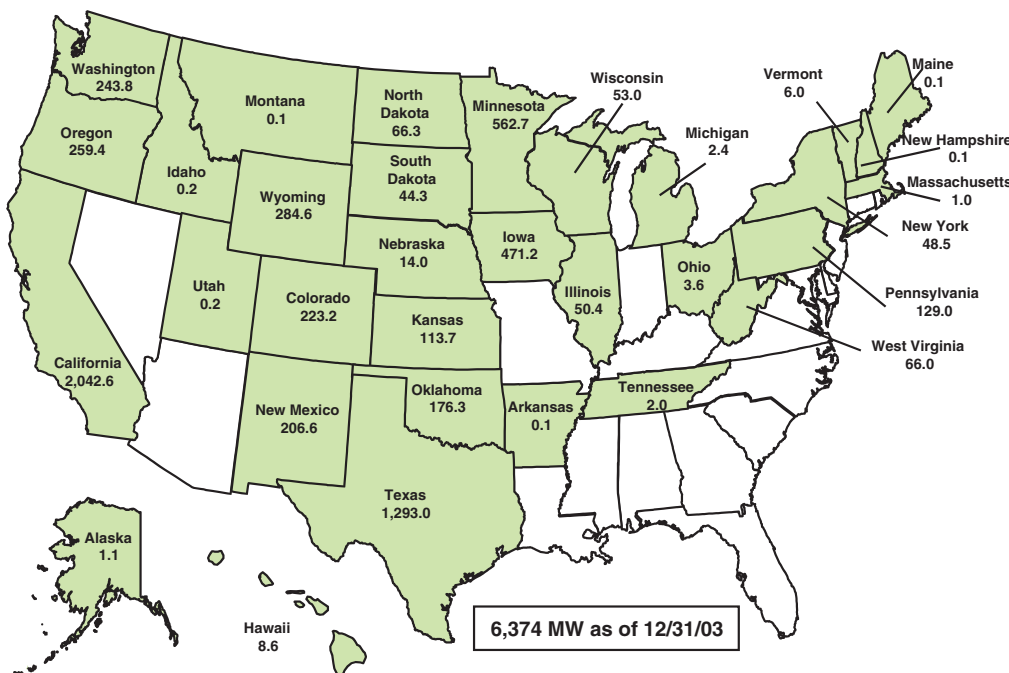

Wind farms of various sizes now operate in 32 states.

## Working Today to Secure Energy for Tomorrow

The mission of the DOE Wind Program is to support the President’s National Energy Policy published in 2001 by increasing the viability and use of advanced wind energy technology. The program leads the Nation’s effort to improve wind energy technology through public/private partnerships. These partnerships enhance domestic economic benefit from wind power development and coordinate activities that address barriers to the increased use of wind energy.

The program is divided into two primary areas; technology viability and technology application. To



## United States Wind Resource Map

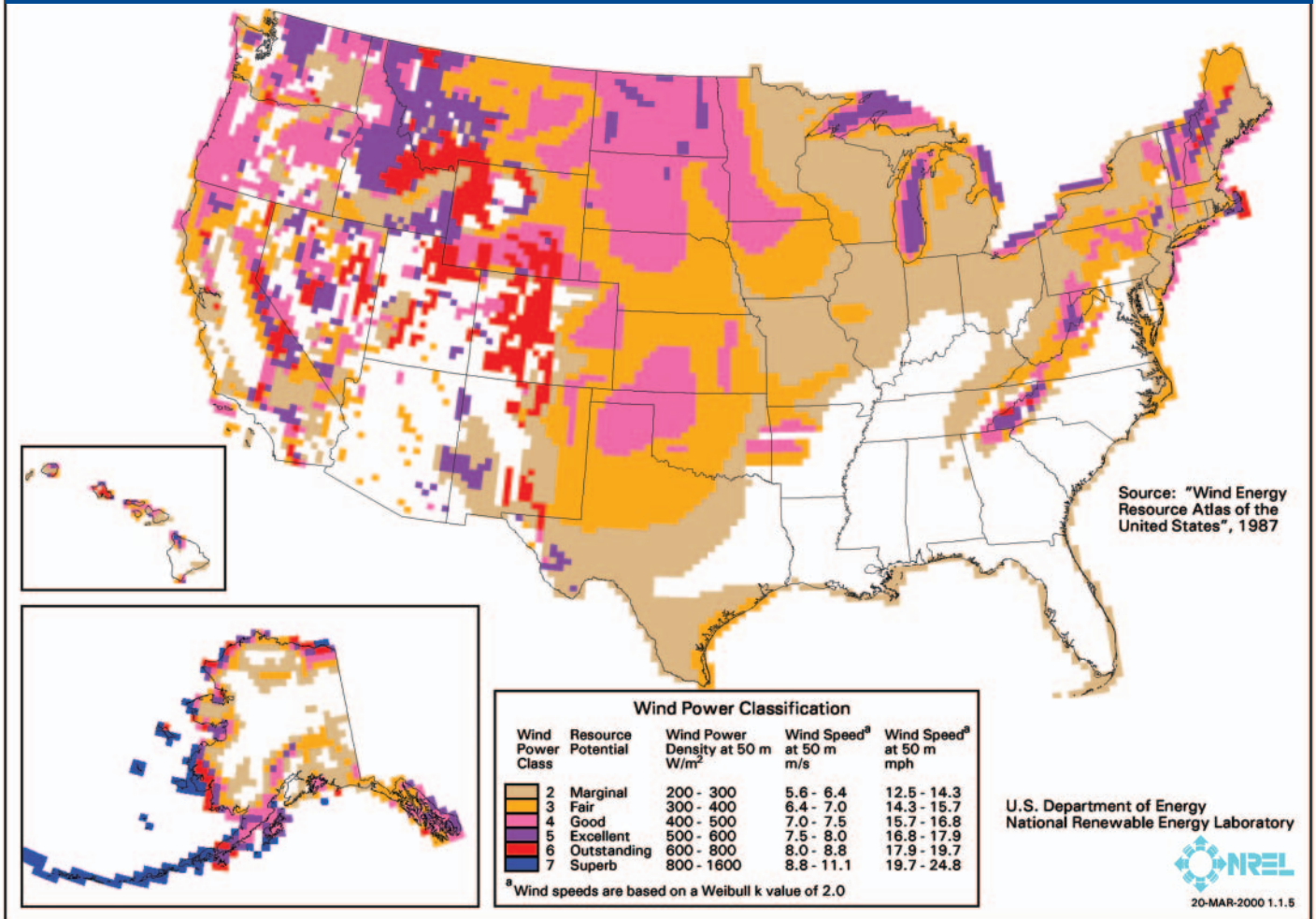

## Cost of Wind Energy

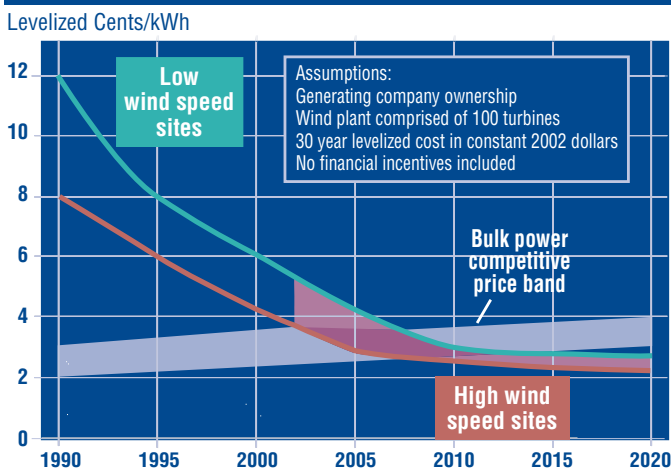

While the cost of wind energy has dropped dramatically since 1990, the goal of the Wind Program is to further reduce the cost to \$0.03/kWh in low wind speed areas by 2012.

increase the viability of wind energy technology, researchers must reduce its cost and increase its efficiency so it can operate cost effectively in low wind speed resource environments. The current cost of wind energy produced by utility-scale systems is \$0.04–\$0.06/kWh in Class 4 resource areas. The goal of the Wind Energy Program is to decrease that cost to \$0.03/kWh in Class 4 resource areas onshore and to \$0.05/kWh for offshore applications by 2012. The goal for distributed wind technology is to reduce the cost of electricity from distributed wind systems to \$0.10–\$0.15/kWh in Class 3 wind resources, the same level that is currently achievable in Class 5 winds, by 2007.

To increase the application of the technology, the program works to address barriers that impede industry growth – integration into utility systems and other applications and energy sector acceptance. To resolve integration issues, they work with industry and utility representatives to understand how a variable supply like wind energy can be successfully integrated into the utility grid. To gain acceptance, increase public awareness, and improve policies, the program forms strategic partnerships on state and regional levels and provides technical support and information. ♦



# **WIND POWER TODAY**

## **Developing New Territories with Low Wind Speed Technologies**

Wind energy technologies have advanced leaps and bounds from the small multibladed machines that pumped water and powered direct current applications in the 1930s and 1940s to the quiet, sleek, efficient power plants that provide energy to thousands of homes today.





Although 6374 MW of wind capacity may seem like a lot to the average homeowner, it provides a very small percentage of the electricity our nation uses and is a fraction of what our country could produce if we took full advantage of our wind resources. The goal of the U.S. wind industry is to increase our nation's wind capacity to 100 gigawatts (GW) by 2020.

The winds that blow across the Great Plains alone could generate more electricity than our country uses. However, not all those winds qualify as the excellent Class 6 and 7 resources (annual average wind speeds of 6.7 m/s at a height of 10 m [15 mph at a height of 33 ft.] and greater) on which the current industry has been built. As the wind industry continues to grow, the excellent wind resources that are close to load centers and are economical will be developed, leaving only hard-to-access sites and sites with lower wind speeds.

Wind energy technologies have moved far beyond the small multibladed machines that pumped water and powered direct current appliances in the 1930s and 1940s to become quiet, sleek multimegawatt power plants that power thousands of homes today. The cost of power from these machines has fallen by 80% over the past 30 years. Many of these advances can be attributed to R&D work conducted under the auspices of DOE's turbine development activities during the past decade. The next generation of machines may not show as dramatic an improvement in appearance and cost reduction, but industry members believe that incremental improvements to turbine efficiency can reduce the cost of wind energy an additional 30% or more.

DOE issued a request for proposals on low wind speed technologies to its industry partners in October 2001. The request provided bidders an opportunity to participate in one of three technical areas: 1) concept and scaling studies, 2) component development, and 3) full-scale prototype turbine development. In 2002, the first contracts were awarded, and researchers at DOE's National Renewable Energy Laboratory (NREL) and Sandia National Laboratories (SNL) began working with industry partners to develop technology improvement opportunities. In July 2003, DOE launched the second phase of its low wind speed research by releasing another request for proposals and received 45 proposals by November. NREL will start awarding contracts for qualifying proposals in 2004.

## Boosting Industry Growth through Public/Private Partnerships

The objective of a subcontract awarded to Clipper Windpower, Inc., as part of the Phase I research, is to develop a 1.5–2.5-MW Quantum prototype turbine that will incorporate advanced turbine components projected to achieve DOE's low wind speed COE goals. The company is reducing capital costs through innovative approaches to design and manufacturing processes. Clipper's innovative design will include a multiple-generator drivetrain and advanced controls. They are also exploring a variable diameter rotor for improved performance in low wind speed areas and are considering including a self-erecting tower.

Researchers at NREL's National Wind Technology Center (NWTC) are working with GE Wind Energy to develop an advanced multimegawatt turbine that can approach DOE's low wind speed goals. Using DOE's Next Generations





NREL is working with GE Wind Energy to develop an advanced multimegawatt turbine with a host of pioneering features.

Turbine Project as a stepping stone, NREL is planning to enter into a subcontract with GE to develop an advanced multimegawatt prototype that will incorporate a host of pioneering features, including multipiece rotor blades constructed of advanced materials and optimized for low noise levels, advanced controls, diagnostic systems, an innovative drive-train, and taller towers with load reducing features. GE plans to start engineering the turbine in 2004.

In addition to producing full-scale prototype turbines, researchers are working with industry partners to analyze every component, from the base of the tower to the tips of the turbine's blades, for opportunities to improve the technology and reduce costs. Although component improvements may be incremental, when combined, they can have a significant cumulative impact on the system's efficiency and cost of production.

#### **Advanced Tower Designs May Reduce Costs**

As wind turbines increase in size and rise to greater heights to take advantage of higher energy winds, their towers require more materials and comprise a larger percentage of the project's cost (18% for today's machines and 20%–25% for the multimegawatt machines). Efficient construction methods can optimize material quantities and reduce costs.

According to a WindPACT study published in 2001, traditional towers taller than 65 m (213 ft) present serious logistical problems during transport and installation. With traditional tapered steel tower designs, taller towers require larger base diameters, causing problems and additional expenses in transport. The taller tapered steel towers also require large, expensive cranes for construction.



Researchers are working with industry partners to analyze every wind turbine system component, from the base of the tower to the tips of the blades, for opportunities to improve the technology and reduce costs.



One way to reduce the cost of transporting and constructing the larger towers is to construct all or part of a tower on site and to explore the possibilities of self erecting designs. Several studies currently underway are looking at innovative construction materials and self erection concepts that may allow 100-m towers without adverse cost impact.

**New Drivetrains Produce More and Weigh Less**

Several subcontracts awarded between 2000 and 2002 to Global Energy Concepts (GEC), Northern Power Systems (NPS), and Clipper Windpower pursued different approaches to reducing the costs of drivetrain components—generators, gearboxes, shafts, and bearings—for 1.5-MW turbines. Such components convert the slow-rotating mechanical energy of the rotor into electrical energy.

In 2003, GEC finalized a new design for a single-stage permanent magnet (PM) drivetrain. The preliminary design analysis shows high efficiency at low wind speeds, and annual energy production estimates that are 3% higher than baseline. Production costs for the single-stage PM drivetrain are estimated to be 22% lower than for the baseline drivetrain, and it shows potential for reducing overall turbine COE by 10%. GEC is completing a prototype of the new drivetrain in 2004 and has conducted factory testing. The drivetrain will undergo design validation testing at the NWTTC.

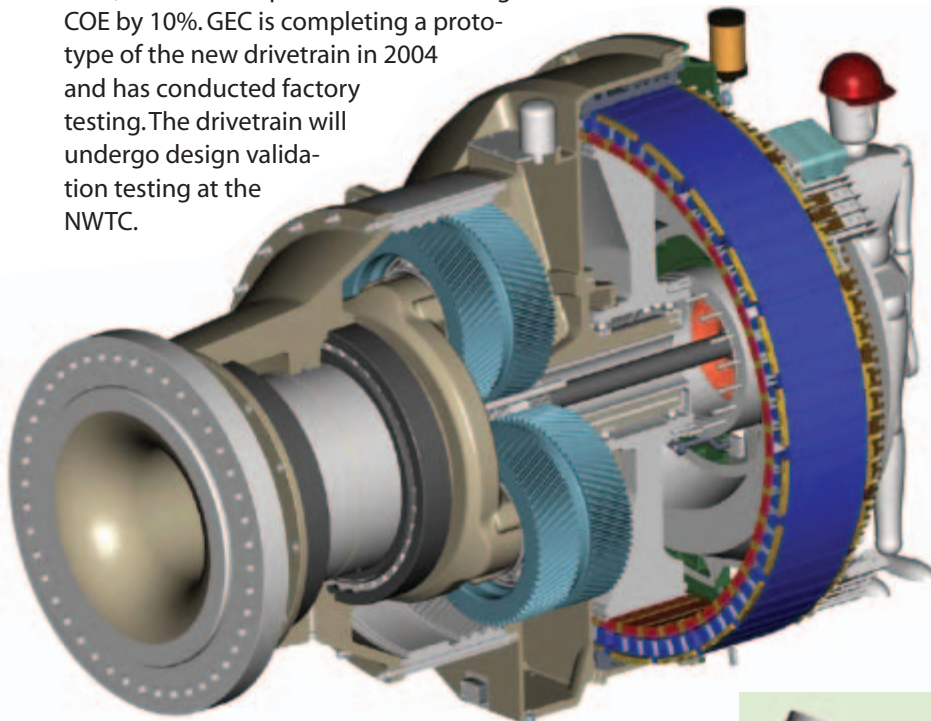

Preliminary analysis of GEC's new single-stage PM drivetrain shows high efficiency at low wind speeds, and annual energy production estimates that are 3% higher than baseline.

Northern Power Systems has designed a 1.5 MW direct-drive permanent magnet generator and has also designed and fabricated a novel, full power converter that will allow variable-speed operation. The direct drive configuration, which has broad commercial appeal, eliminates the gearbox leading to real improvements in reliability and reductions in cost of energy. In 2003, Northern

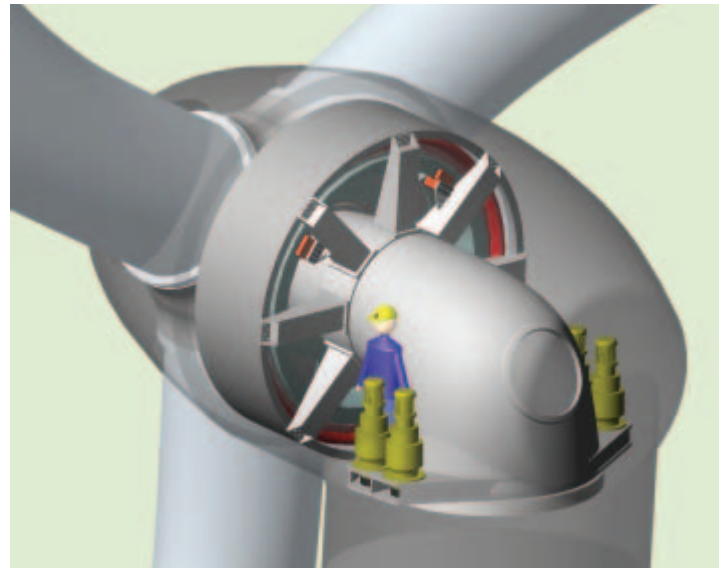

The NPS direct drive configuration eliminates the gearbox, leading to real improvements in reliability and reductions in COE.

began fabrication of the new drivetrain and will ship it to the NWTTC in 2004 for testing and validation.

Clipper Windpower completed its design for a 1.5 MW drivetrain that is lighter weight and potentially more efficient than conventional drivetrains. In 2003, Clipper produced an eight-generator, distributed generation drivetrain that is being tested at the NWTTC.

The drivetrain, which includes variable-speed power electronics, eight generators, and a gearbox, is more compact and has proven to be 30% lighter than conventional drivetrains. It was designed to fit most 1.5-MW scale platforms and can be used as a retrofit for new turbines. Clipper hopes to make this concept available to other turbine manufacturers in 2004.

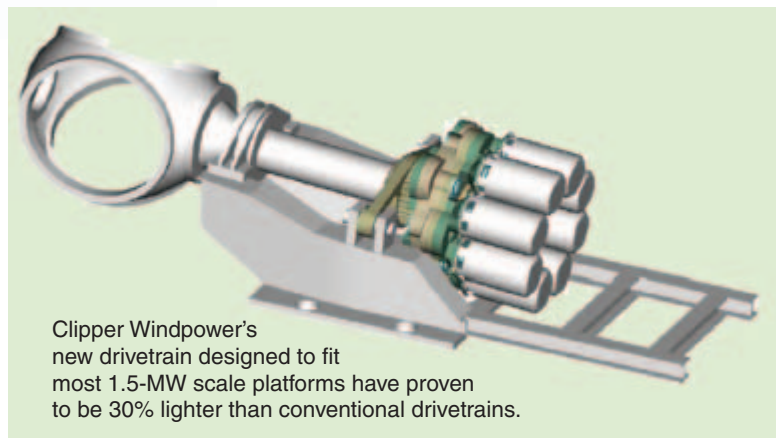

Clipper Windpower's new drivetrain designed to fit most 1.5-MW scale platforms have proven to be 30% lighter than conventional drivetrains.

## Wind Turbine Blades Play Crucial Role in System Design and Cost

Because the amount of energy a wind turbine generates depends on the amount of energy captured by its blades, longer blades capture more energy. The production of larger cost-effective wind turbines for lower wind speed sites depends on industry's ability to produce longer, stronger blades. However, as blades become longer, they become heavier, more expensive, and they subject the turbine to greater loads, which stresses other components. Because blade and rotor manufacturing costs are typically around 25% of the total turbine cost, the wind industry is pursuing innovative approaches to blade design and manufacturing to minimize production costs.

Researchers at Sandia National Laboratories (SNL) are working with universities and manufacturers to develop longer, stiffer, more slender blades that incorporate advanced lighter weight materials and aeroelastic designs and use innovative manufacturing processes that reduce costs, improve quality and reliability, and broaden the U.S. blade manufacturing base. To achieve these objectives, SNL's research focuses on new ways to design and fabricate blades that incorporate advanced materials and aeroelastic designs.

Promising advanced materials include carbon fiber and carbon/glass hybrid composites. Although carbon fibers are more expensive than traditional fiberglass materials, they are much stronger, weigh less, and can take more stress cycles than traditional materials. Using lighter carbon will reduce the loads on the blades and other turbine components.

In 2002, SNL began working with two teams of designers, one led by K. Wetzel, Inc., working with Wichita State University, and the other teaming blade manufacturer TPI with the consulting firm GEC, to design and fabricate two 9-m (29.5 ft) carbon-hybrid blades. In 2003, the first team completed the designs for the blades: one with carbon/glass fiber hybrid materials on a conventional lay-up and the second with carbon and glass laid off axis to optimize bend-twist coupling effects. Preliminary analysis shows that the weight of the carbon-hybrid blade decreased 20% from the baseline and the weight of the twist-coupled blade decreased 10%–15%. The incorporation of twist coupling should reduce fatigue loads by an additional 10%–20%.

In addition to investigating new materials, researchers are analyzing blade structure and design to understand how loads affect the blades. To aid in the design and manufacturing of advanced blades that incorporate innovative materials, SNL developed a Numerical Manufacturing and Design (NuMAD) software tool that enables designers to model blades in significantly less time than conventional tools. A model that took 15 hours to create using traditional design software took less than an hour using NuMAD. The program can identify weak areas in the

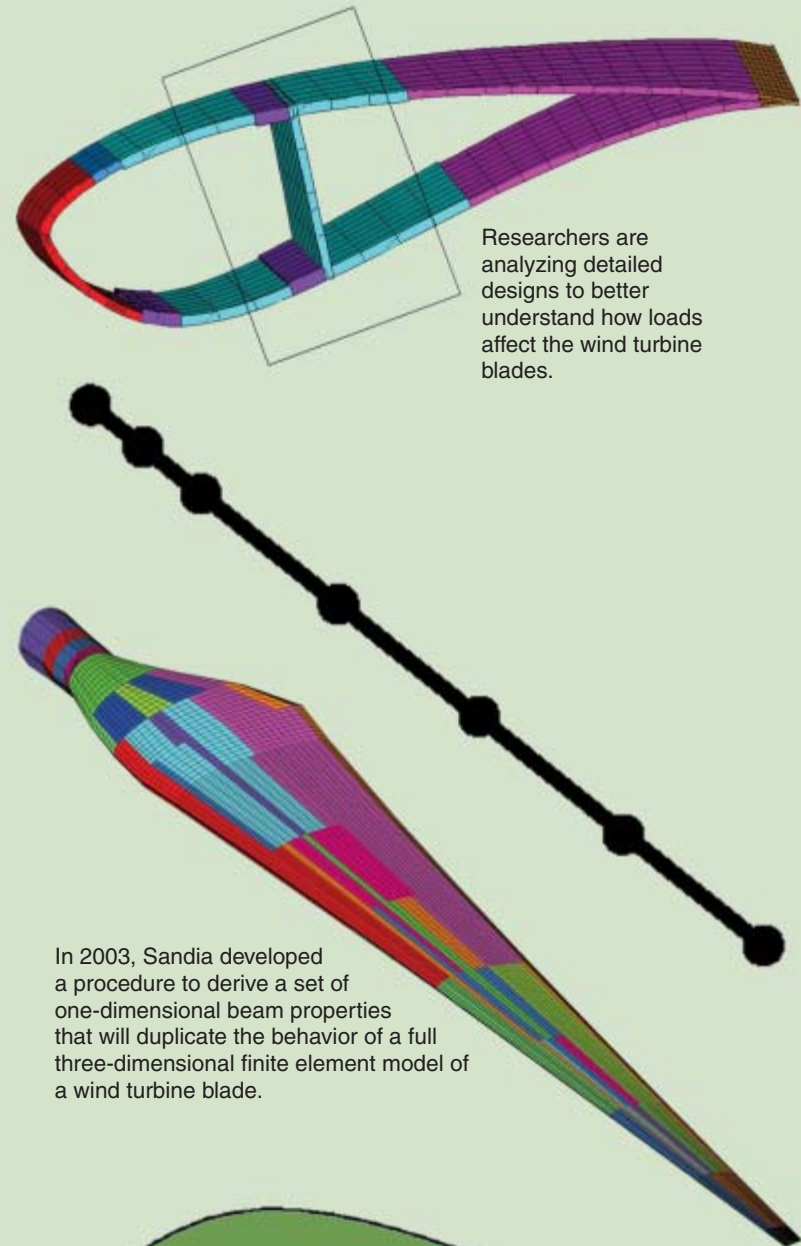

Researchers are analyzing detailed designs to better understand how loads affect the wind turbine blades.

In 2003, Sandia developed a procedure to derive a set of one-dimensional beam properties that will duplicate the behavior of a full three-dimensional finite element model of a wind turbine blade.

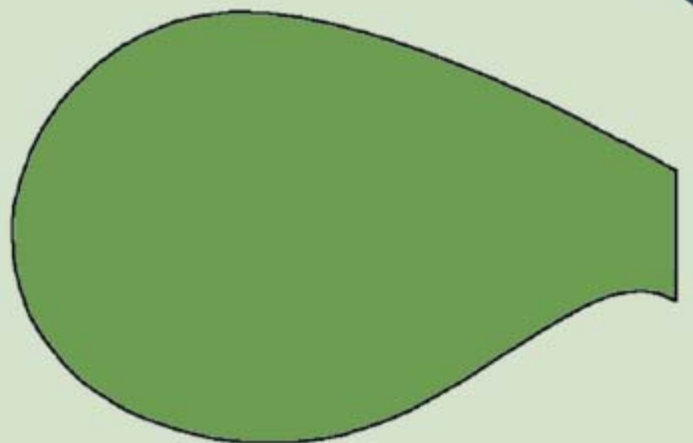

In 2004, Sandia plans to pursue innovative blade shapes that incorporate blunt trailing edges to improve the structure, simplify the manufacturing, and reduce the weight without sacrificing the aerodynamic performance.



## NREL's New Hydraulic Resonance Blade Test System Cuts Test Time in Half

As wind turbine blades become longer and stronger, they become more difficult to test for endurance. The test methods developed for smaller blades are not as effective for larger blades. To accommodate the larger blades, researchers at NREL developed a new hydraulic resonance blade test system (below) that can be scaled up as the blades increase in length. The old method uses a hydraulic actuator to push the blade up and down for millions of cycles over a period as long as four months. The new system uses a 317- to 453-kg (700- to 1000-lb) weight housed in a stand attached to the end of the blade. The amount of weight used depends on the size of the blade. The weight is precisely controlled to oscillate up and down, which excites the blade at its natural flap frequency. The new test uses one-third the energy that the conventional method uses, and the blade oscillates at more than twice the rate. Instead of taking as long as four months to apply 3 million cycles to fatigue test a blade, researchers can now do it in less than two months. A test duration of three million cycles is typically used to represent the 20-year lifespan of a blade.



The new system, which can test blades as long as 70 m (230 ft), is the only one of its kind in the world. In December 2003, NREL researchers completed a fatigue test using the new system on a 37-m (121.4-ft) blade built by GE Wind. The completion of this first test validated the operation of the new system, and in 2004, they will begin running fatigue tests on 34- and 45-m (111.5- and 147.6-ft) blades.

design, predict failure modes, and let the designer know if the new design can handle certification loads.

NuMAD can develop complex three-dimensional models that examine the internal stress distribution within the blade, but these models are too detailed for use in a system aeroelastic analysis that represents the blades as a series of one-dimensional beam elements. In 2003, SNL researchers developed a procedure to derive one-dimensional beam properties that will duplicate the behavior of a full three-dimensional finite element model of a wind turbine blade. The new procedure will enable blade designers to seamlessly go back and forth between detailed three-dimensional shell models, to check strength and durability, and one-dimensional models for checking system dynamics and control system design.

In 2004, SNL plans to pursue innovative blade shapes that incorporate blunt trailing edges to improve the structure, simplify manufacturing, and reduce weight without sacrificing aerodynamic performance. Researchers predict

that although the new blade designs will weigh less and cost less to produce, they will be stronger and more efficient.

### **Aerodynamics Research Improves Turbine Engineering Design**

To reduce the COE of low wind speed operation, researchers must find ways to maximize turbine power production while minimizing detrimental structural loads. Aerodynamics govern both objectives. To predict and control turbine aerodynamics, researchers at NREL and SNL are pursuing a balanced approach that exploits the synergy between computation and experiment. Full-scale field and wind tunnel experiments identify and measure the aerodynamics that determine turbine operation. These aerodynamics are then captured in accurate, reliable computational models for engineering design. To accelerate progress, modeling methodologies developed for aircraft and rotorcraft are being adapted for wind turbine aerodynamic prediction. Aeroacoustics

was recently identified as a high interest area, and research is underway to predict and minimize turbine aeroacoustic signatures.

### **Understanding Turbulent Wind Patterns on the Great Plains**

Another challenge facing low wind speed turbine developers is understanding the turbulence and fatigue environment at the height at which the larger turbines operate. Although researchers know that wind speeds increase with altitude, they suspected, but had not yet verified, the existence of turbulent wind patterns at the greater heights. On the Great Plains, where there is an abundance of low wind speed resources, they know the increase in wind speed is related to the low-level jet streams that frequently form near the ground at night, but they did not know the characteristics of the turbulence under these jets and how it might affect a wind turbine's operations or lifespan.

In 2001, NREL researchers began working with GE Wind to collect wind measurements from GE's 120-m (400-ft) tower in southeast Colorado. The tower was instrumented with fast-response sonic anemometers installed at several different heights. With no moving parts, these anemometers use very high-frequency sound waves to measure very small details in the wind. The tower was also instrumented with



GE's 120-m (400-ft.) tower, in southeast Colorado, collected 40,000 detailed turbulence measurements to analyze.

equipment to measure temperatures, humidity, and barometric pressure. After one year, researchers had collected 40,000 detailed data records.

In 2002 and 2003, they used state-of-the-art Doppler SODAR (acoustic wind profiler) and LIDAR (laser wind speed measurement) remote sensing systems to map the vertical and horizontal extent of coherent turbulent wind patterns associated with low-level nocturnal jets above the tower measurements. By combining these measurements with data previously collected on the NWTC's Advanced Research Turbine, researchers have been able to verify the presence of organized turbulent eddies that form beneath the jet at heights where multimegawatt turbines will operate. When analyzed, the new data will help researchers develop simulations of turbulence that will be used as the wind input to turbine design codes. This will allow design simulation to include conditions at the heights where the larger wind turbines need to operate reliably. The research will lead to turbine designs that minimize damage and operate efficiently in these turbulent conditions.

### **Distributed Generation Enhances National Energy Supply**

Although the use of small wind generators to supply direct current power for lights and appliances on farms and ranches was commonplace in the early 1930s and 1940s, windmills began to fade from the rural landscape with the advent of the rural electric system. Today, as traditional fuel prices escalate and power supplies fluctuate, rural landowners, small businesses, and homeowners are once again considering wind power to supply all or part of their electricity needs. Small wind systems can help enhance local energy supplies and stimulate rural economies. The small wind industry estimates that 60% of the United States has

### **Field Verification Program Turbines Produce Green Power**

In an effort to encourage the deployment of small wind turbines, NREL issued a field verification subcontract to Northwest Sustainable Energy for Economic Development (NWSeed). Under this subcontract, five 10-kW wind systems were installed; three in Montana and two in Washington. As part of the DOE/NREL regional field verification project, the systems were equipped for power monitoring and data collected is sent to NREL. All of the systems are grid-connected and excess power is sold to area utilities and marketed by Bonneville Environmental Foundation as green power.





enough wind resources for small turbine use, and 24% of the population lives in rural areas where zoning and construction codes permit installations.

To ensure that the small wind industry continues to enjoy the growth it has experienced over the last 10 years, researchers are working with industry members to improve designs, increase efficiencies, and improve costs and reliability. As part of its R&D focused on distributed wind systems in 2003, DOE awarded \$1.5 million in grants to 10 firms to enhance the cost-effectiveness of small wind turbines. The goal for distributed wind technology is to reduce the cost of electricity from distributed wind systems to \$0.10–\$0.15/kWh in Class 3 wind resources, the same level that is currently achievable in Class 5 winds, by 2007.

One project selected for award was for Northern Power Systems (NPS) of Waitsfield, Vermont, to develop a new 100-kW turbine. NPS developed a 100-kW machine for use in extreme cold weather regions



## Small Wind Research Turbine (SWRT)

Many issues remain poorly understood when it comes to the specific behavior of small wind turbines, such as furling behavior, blade and tower loads, thrust loads, and the effect of overspeed protection on turbine performance. Although small wind turbine manufacturers have historically relied on variable geometry testing to design wind turbines, they are now relying more on models to simulate wind turbine performance. However, there is a lack of quality data that turbine designers can use for a comparison. NREL's SWRT study, started in 2003, will provide the wind industry with quality operating data on loads and performance to help members of the small wind industry gain a better understanding of small turbine behavior.

The SWRT will be the first study to provide accurate thrust measurements for a small turbine. Accurate thrust measurements are crucial for developing models for furling. In addition to thrust and furling measurements, the SWRT turbine is outfitted with two three-dimensional sonic anemometers that measure wind speeds upwind and in the tail wake. The turbine is also tested for tower bending, yaw rate, shaft bending and torque, blade bending, rotor speed and other related parameters.

Data produced from the SWRT project will enable small wind turbine manufacturers, as well as those involved with modeling and certification of small wind turbines, to better understand small wind turbine operation and how design parameters affect operation and loads. The data from the SWRT is being compared to the results of ADAMS and FAST models that have been modified to include small wind turbine furling behavior to see how well those models perform and what enhancements they need to properly model small wind turbines.



under a subcontract to NREL in 2000 – 2001. This design will be modified for use in agricultural applications such as dairy and hog farming. NPS will begin work on the new system in 2004.

NWTC researchers are continuing to support a small wind turbine project with Bergey Windpower Company of Norman, Oklahoma, and Southwest Windpower in Flagstaff, Arizona. Bergey has worked with the NWTC since 1997 to perfect a 50-kW wind turbine for distributed applications. The machine incorporates a new airfoil design, variable speed operation, and passive controls (tail and furling) rather than a mechanical brake. On the Bergey turbine, in high winds, the tail stays fixed into the wind and the rotor moves around the tail into a vertical furling or folded position. This reduces the rotor's exposure to the wind, which reduces the rotational speed and protects the turbine from damage. The new airfoil, designed for quieter operation, will fit three rotor diameters so the turbine can be adapted to different wind regimes. Bergey plans to have the turbine commercially available in 2004.

The NWTC began working with Southwest Windpower in 2002 to develop an efficient and cost-effective 1.8-kW turbine for residential use. In 2003, Southwest completed its preliminary design for the Storm 1.8-kW turbine and began testing to validate its power rating. Initial test results indicate that the turbine meets its rated power objective. The company plans to design and build a prototype for testing in 2004.

## Grid Integration – Gaining Equitable Access to the Utility Grid

Because wind energy is the fastest growing form of electric generation, more utilities are seriously evaluating its addition to their generation portfolios. However, because wind is a variable resource, it raises concerns about how it can be integrated into routine grid connections, particularly with regard to the effects of wind on regulation, load following, scheduling, line voltage, and reserves. A lack of acceptance in this area can inhibit market acceptance and hinder the increase of our nation's wind energy capacity.

The goal of DOE's system integration activity is: "By 2012, complete program activities addressing electric power market rules, interconnection impacts, operating strategies, and system planning needed for wind energy to compete without disadvantage to serve the Nation's energy needs."

To achieve this goal, program researchers are assisting regional electric system planning and operations personnel to make informed decisions about the integration of wind energy into their systems. By conducting integration research, researchers can provide utility personnel with unbiased information on the impacts wind energy. Integration research is being conducted in four areas; grid systems modeling and analysis, wind utility operations and

ancillary service analysis, emerging wind applications, and distributed small systems integration.

To help utilities understand the variance of wind power and gain a better understanding of operational issues, researchers monitor and analyze existing wind power plants. Their assessment will validate factors such as voltage stability, power regulation, and power system performance issues due to wind variability and will provide a history of the performance of operating wind power plants interconnected with large electrical grids. Based on this analysis, researchers can then develop models that simulate power plant operations under various wind and system conditions to investigate power quality, voltage stability, and reactive power support issues.

Under the utility operations and ancillary service analysis, researchers are studying generation and transmission issues in relationship to wind power. As electricity needs continue to grow, utilities need to plan for and install new generation and transmission lines. To help utility planners better understand and improve the electrical transmission and generation planning process for wind energy, researchers are providing technical information, analysis, and methods of development where needed. To ensure that wind receives equitable consideration in utility deliberations and rulemaking proceedings, Wind Program personnel are also working with independent system operators, regional transmission organizations, the Federal Energy Regulatory Commission, and state and local utility planners.

## Laying the Groundwork for New Markets: Wind Powering America

Launched in 1999, the goal of Wind Powering America (WPA) is to increase the use of wind energy in the United States so that at least 30 states have 100 MW of wind capacity by 2010. Increasing the use of wind energy will diversify our nation's energy mix, bring new income to farmers and rural landowners, and generate new jobs.

To achieve its goal, WPA uses a state-, utility-, and Native American-based strategies to identify and address barriers to wind development. A national team undertakes activities with industry partners that focus on state wind support, utility partnerships, tribal outreach, and innovative market mechanisms to support the use of large- and small-scale wind.

### State-Based Activities

**State-based activities include landowner and community meetings, state wind working groups, workshops, anemometer loan programs, state wind resource maps, and state-specific small wind consumer guides.**

WPA's landowner and community meetings and workshops educate audiences about the current state of wind technology, economics, state wind resources, economic development impacts, policy options/issues, and barriers to wind development. State audiences include policy makers,



state energy officials, landowners, utilities, community groups, and economic development interests. The key outcome of these meetings is the formation of a wind-working group in each state with a set of priority activities to encourage wind development. To date, WPA has supported the formation of 19 state wind-working groups. To equip the groups with the necessary information and resource materials to develop and implement an effective outreach effort, WPA published and distributed the *State Wind Working Group Handbook* accompanied by a CD of topical PowerPoint presentations in 2003.

In addition to the state wind working groups, WPA helps developers identify the areas with the best wind resources through cooperative mapping and wind measurement programs. WPA supports a public/private sector mix of wind resource analysts and meteorological consultants to update state wind resource maps. Identifying the available wind resource in an area is the first step toward evaluation and installation of large and small wind systems. Although developers have relied on the U.S. Wind Resource Atlas, published in 1987, to guide their efforts, modern mapping systems have produced more highly detailed state wind maps.

## Wind Powering America State Wind Summit II

On May 22, 2003, the Wind Powering America Program sponsored the second State Wind Summit, following the American Wind Energy Association's Wind Power 2003 conference in Austin, Texas. Over 100 participants were on hand, including representatives from state energy, economic development, and environmental offices; energy regulators; universities; rural electric cooperative and public power utilities; and the wind energy industry. Summit sessions focused on relevant market and policy issues, wind working group success stories, barriers to state-level action, and Wind Powering America budget and planning issues.

The new maps have resolutions of 1 km (0.6 mi) and finer (in some cases 200 m [656 ft]), in contrast to the old maps that have a resolution of 25 km (15.5 mi). The new technology also enables analysts to overlay the resource maps to show transmission grids; roads; county boundaries; federal, state, and Native American lands; and geographical features. In 2003, the team finalized new maps for New Mexico, Arizona, Nevada, Utah, and Colorado. The maps

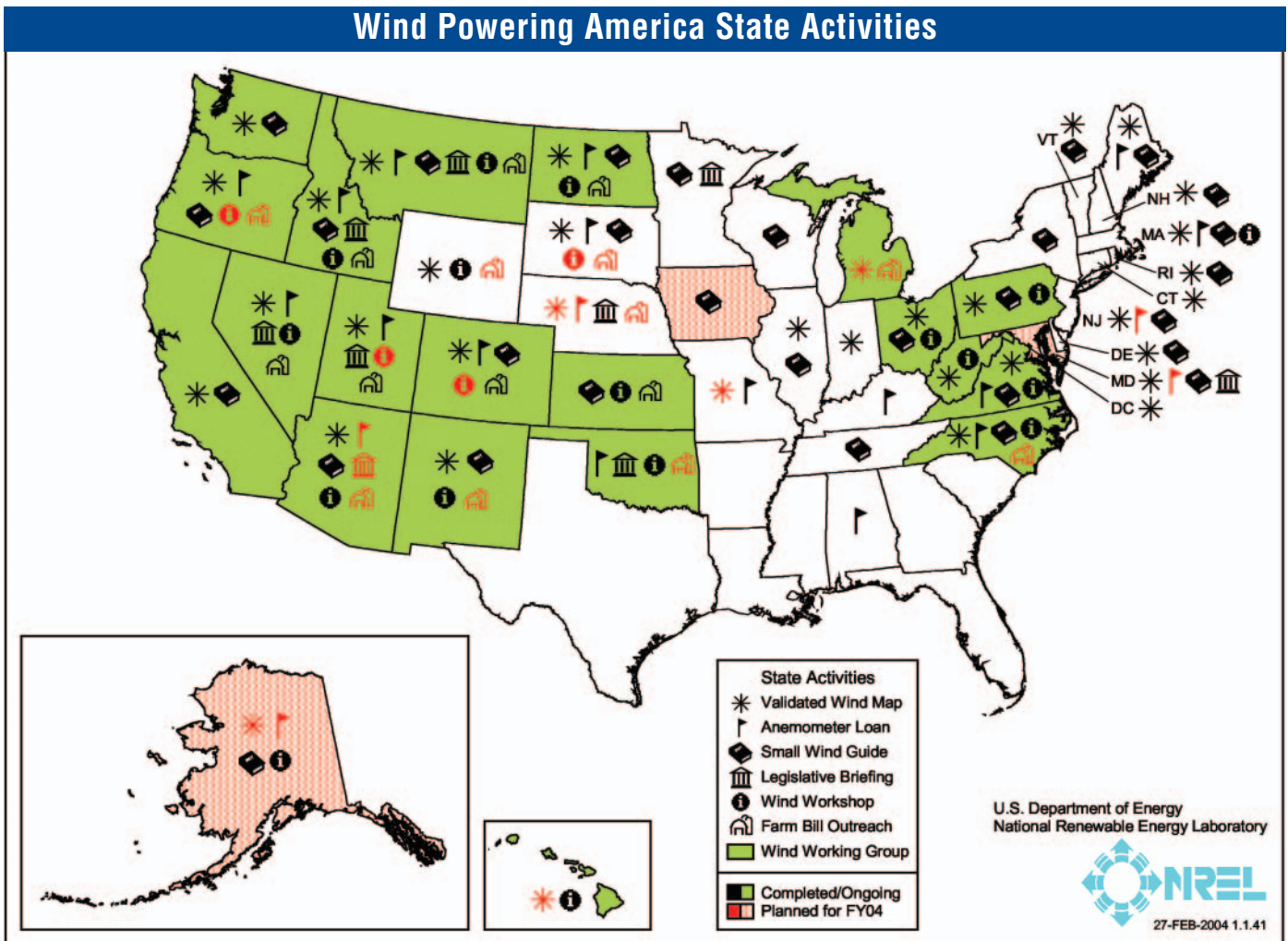

are available on DOE's WPA Web site at [www.eere.energy.gov/windpoweringamerica](http://www.eere.energy.gov/windpoweringamerica).

WPA's anemometer loan program allows land and business owners to borrow anemometers to measure their wind resources for one year without charge. By the end of 2003, WPA had installed anemometers in 20 states. WPA encourages local universities to administer the programs for education purposes.

WPA also has an active small wind systems initiative. As part of the initiative, WPA published 24 state-specific consumer guides that contain wind resource maps and information about small wind electric systems. These guides help consumers determine whether using wind energy systems to provide all or a part of their home or business electricity needs is economically feasible. The first guide, produced in 2001, was *Small Wind Electric Systems: A U.S. Consumer's Guide*. WPA team members then collaborated with state energy officials to customize the guide's cover for each state so it contains a state-specific wind resource map and information about state incentives and state contacts.

In 2003, WPA produced guides for Virginia, Pennsylvania, Massachusetts, Delaware, Rhode Island, Maine, New Jersey, and New Hampshire, and also collaborated with the American Corn Growers Foundation to produce *Small Wind Electric Systems: A Guide Produced for the American Corn Growers Foundation*. WPA also sponsors small-wind-specific workshops and provides technical assistance.

In another state activity, WPA teams up with DOE's Regional Offices and the Environmental Protection Agency (EPA) to promote the use of wind-based supplemental environmental projects (SEPs). When a company violates environmental regulations, it must pay a fine to the state or federal government. The EPA designed SEPs to offer emission violators an alternative to paying the standard fines. Instead of paying the full amount, a company can volunteer to fund environmentally friendly projects. The WPA team provides technical assistance in formulating wind options for interested states. In 2003, WPA published a fact sheet titled *School Wind Energy Project Ideas for Supplemental Environmental Project (SEP) Settlements*.

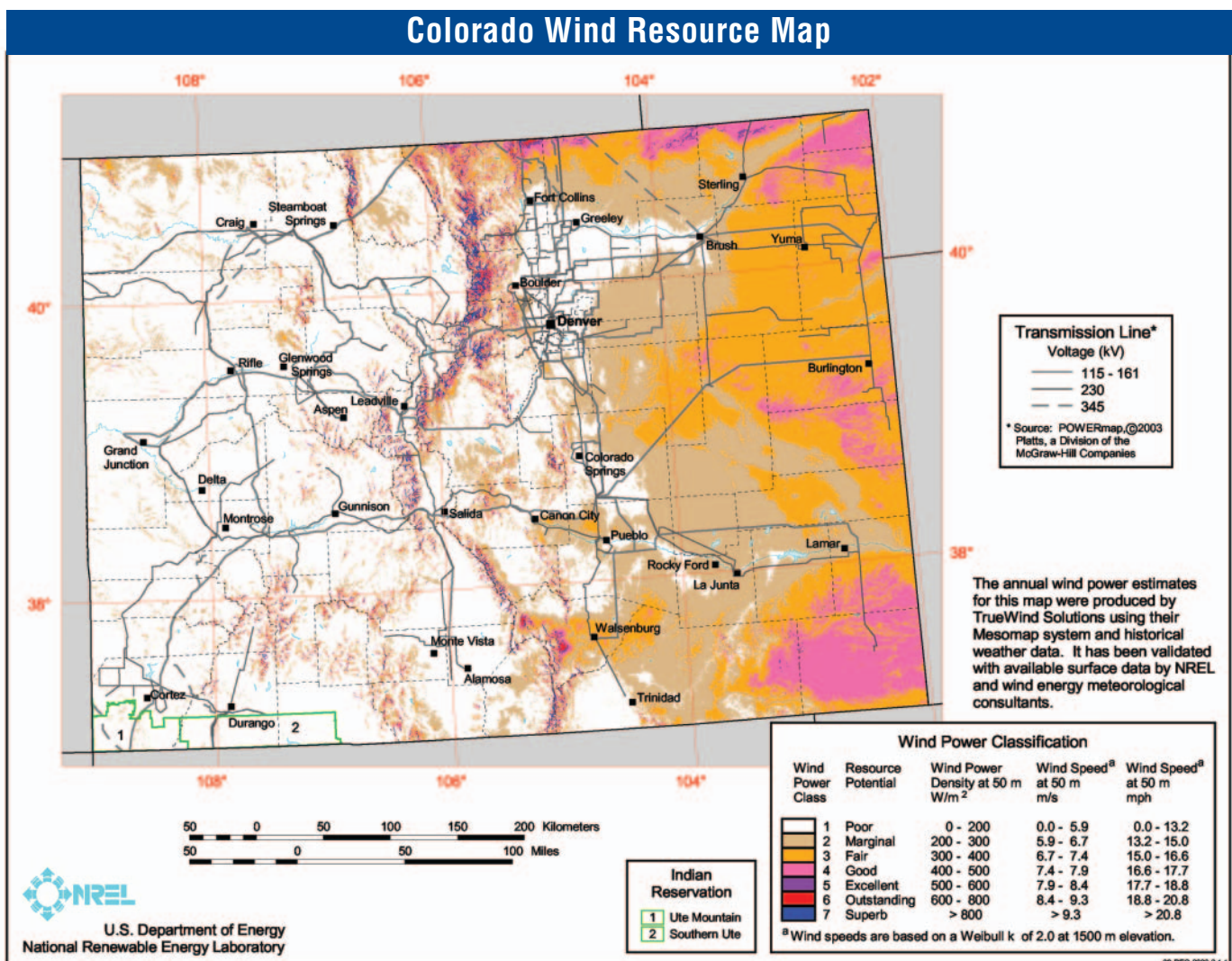

WPA produces state-specific small wind consumer's guides that contain state-specific small wind resource maps, like this map for Colorado, inside the front cover.



## Utility Partnerships

**The key activities of the utility partnerships theme are a public power outreach and recognition program, Power Marketing Administration green tags, and targeted strategic technical analyses.**

Regional transmission constraints, operational policies, and a lack of understanding of the impacts of wind energy on utility grids are three barriers to the future development of wind energy. WPA works to overcome these barriers and meet its goals of increasing the nation's wind energy capacity by working with utilities and utility groups such as the American Public Power Association (APPA), the National Rural Electric Cooperative Association (NRECA), Power Marketing Administrations (PMAs), the National Wind Coordinating Committee's (NWCC) Transmission Working Group, and the Utility Wind Interest Group (UWIG).

During the past 3 years, WPA has worked closely with the utility sector, especially national consumer-owned and public power utilities, to present up-to-date information to their membership and customers nationwide. These cost-shared efforts include co-sponsorship of wind-specific meetings, conferences, and workshops, as well as joint development and distribution of materials containing technical and market specific information and wind project success stories. WPA also provides real-time technical assistance on everything from the state of wind technology and economics, to information on barriers, benefits of wind, and how to get a wind project started. In 2003, WPA and NRECA held workshops in Colorado and South Dakota.

To recognize the leadership and support of wind power by its partners, WPA developed a Wind-Municipal and Wind Utility Coop of the Year Award. The award is presented at each organization's largest national convention. In 2003, WPA and its team of experts named Glenn Cannon, general manager of Waverly Light and Power in Waverly, Iowa, as the first recipient of the Wind-Muni Pioneer Award. Waverly installed the first utility-scale wind turbine in Iowa in 1993. Since then, Iowa has installed approximately 350 wind turbines and is one of the leading states in wind energy development. The award recognized Glenn Cannon's leadership role in helping lead the way for wind energy development across the Midwest. Also in 2003, WPA named Basin Electric, located in Bismarck, North Dakota, as the Wind-Cooperative of the Year. Basin Electric was recognized for its leadership in expanding opportunities for wind energy, including its involvement with an 80-MW wind project, which remains the largest electric cooperative wind farm in the nation. Ron Rebenitsch, manager at Basin, accepted the award. Wind Powering America and its partners APPA and NRECA expect to continue these awards in 2004.



Manager of Basin Electric, Ron Rebenitsch (center), accepts WPA's 2003 Wind Cooperative of the Year award. From left to right — Steve Lindenberg, NRECA/CRN; Jim Powell, DOE/ARO; Ron Rebenitsch, Basin Electric; Gary Williamson, Central Power Electric Coop; Ron Harper, Basin Electric.

## Rural Economic Development

**The key activities of the rural economic theme include outreach to agricultural and rural development interests, economic development analysis tools, case study documentation, Native American wind interest groups, a Native American anemometer loan program, an irrigation pilot project, and an innovative ownership pilot.**

The WPA team works with the state wind working groups and their stakeholders to cultivate rural economic development with wind energy through outreach to state agricultural interests. Although the partnerships vary from state to state, they generally include the state energy offices, the U.S. Department of Agriculture (USDA), local and national representatives, state and local officials, the Farm Bureau,

Although he didn't know it at the time, Larry Widdel's future in the world of wind energy development was secured years ago when his family bought some farmland near Minot, North Dakota. Widdel cleared piles of rocks off the acreage for the family's cattle.

"It was the poorest land we owned," Widdel laughed. "My uncle said, 'Boy, this is awful. We don't own mineral rights. We don't own anything but the air above it.' Who would have guessed that the air above our land might be worth money someday?"

No one could have predicted that Widdel's rocky land, which has an outstanding wind resource and small hills that are perfect for siting wind turbines, would someday feature two 1.5-MW wind turbines. Widdel and his family have joined the ranks of rural landowners who lease their land and cultivate the cash crop of the future: electricity from the wind.



Farmers' Union, representatives of the appropriate growers associations, agricultural schools, the local financial community, county commissioners, and rural development advocates. WPA assists by providing outreach materials, such as wind articles on topics of current interest, case studies, and presentations that working groups and their partners can use to reach key audiences. It also provides specialized training and tools to help decision makers at all levels understand their wind resource, the costs and benefits of projects, policies, and how to develop successful wind projects.

Case study documentation is another part of WPA's outreach effort. In 2003, the WPA team documented the economic development impacts from 20 studies of actual and potential wind projects.

### **U.S. Farm Bill Funds Renewable Energy Systems**

On April 8, 2003, the USDA announced the availability of \$23 million in grants for fiscal year 2003 to help farmers, ranchers, and rural businesses purchase renewable energy systems and make energy efficiency improvements. Section 9006 of the 2002 Farm Bill provides this funding for wind,

## **U.S. Corn Growers Support Wind Energy**

In April 2003, the American Corn Growers Foundation, which works in partnership with WPA, commissioned a nationwide, random, and scientific survey of 500+ corn farmers in the 14 states that represent nearly 90% of the nation's corn production. The poll found that 93.3% of the nation's corn producers support wind energy; 88.8% want farmers, industry, and public institutions to promote wind power as an alternative energy source; and 87.5% want utility companies to accept electricity from wind turbines in their power mix.



Unlike most electricity generation technologies, wind energy developments are highly compatible with other land uses such as farming and ranching. Today's wind farms use a small percentage of the land to provide farmers, ranchers, and rural landowners with additional income.

solar, biomass, geothermal, hydrogen from renewables, and building and energy efficiency projects.

Thirty-eight wind project applications were reviewed in 2003, and \$7.39 million was awarded to wind projects. This funding provides an excellent vehicle for wind-related rural economic development. As part of its outreach effort, WPA is sponsoring landowner and community meetings and statewide workshops to communicate these opportunities for wind development to rural communities.

### **Wind Energy Finance Tools Provide Economic Analysis of Wind Projects**

In 2003, the WPA team also improved the usability of its Wind Energy Finance tool, an online calculator for economic analysis of wind projects (<http://analysis.nrel.gov/windfinance>) with more than 1,000 registered users. Users enter data about a project, including size, capacity factor, capital costs, operating costs, financing details, and tax information. They can enter minimum values for rate of return and debt service coverage ratios, and the program will calculate the minimum energy payment needed to meet those goals. Alternatively, the



user can enter a first-year energy payment and the program will calculate the rate of return, coverage ratios, etc. Plans include linking the Wind Energy Finance Tool to the data that underlie the wind maps.

Another economic analysis tool, the Jobs and Economic Development Impacts (JEDI) model, is designed to demonstrate the economic benefits associated with developing wind power plants in the United States. The primary goal in developing this state-level model is to provide a tool for wind developers, renewable energy advocates, government officials, decision makers, and other potential users to easily identify the local economic impacts associated with constructing and operating wind power plants. A strong emphasis was placed on designing the model in a user-friendly format that could be easily modified to accommodate varying levels of project-specific information and user skill. No experience with spreadsheets or economic

modeling is required. It provides on-line instructions for entering data and detailed information to help users understand the type of data required. An add-in-location feature allows the user to model county or regional impacts. The tool's output identifies the construction, operation, and maintenance costs and local spending on debt and equity payments, property taxes, and land lease payments. The output also provides an analysis of local jobs, earnings, and economic activity, including one-time impacts from construction and ongoing impacts from operations.

### Helping Native Americans Develop Wind Power

The WPA team works with Native Americans on the mainland, in Alaska, and in Hawaii in their efforts to explore development of their wind power resources. The United States is home to more than 700 Native American groups and corporations that control 38.8 million hectares (96 million acres) in the United States. Many of these groups have

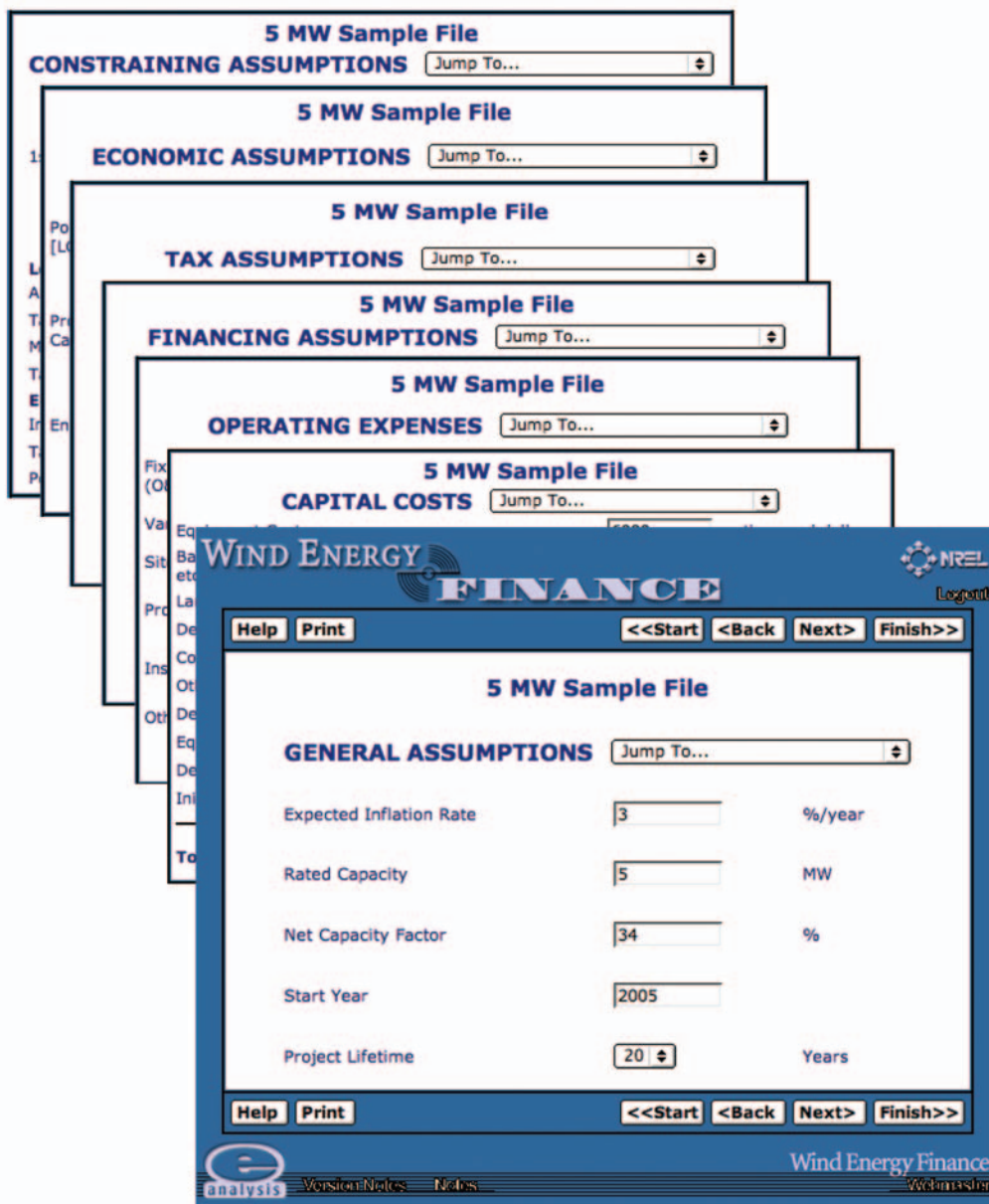



*As part of its Native American outreach, DOE's Wind Powering America program has initiated a quarterly NAWIG newsletter to present Native American wind information, including projects, interviews with pioneers, issues, WPA activities, and related events. It is our hope that this newsletter will both inform and elucidate comments and input on wind development in Indian Country.*

#### Rosebud Sioux: First Tribe in the Nation to Sell Wind Power

Alex "Little Soldier" Lunderman had a vision. The former Rosebud Sioux tribal chairman saw a long line of people behind him walking toward a traditional tipi. In the tipi, he saw computers and other kinds of technologies that his people could use to protect their Mother Earth, and he knew that generating clean electricity from the Four Winds could help his people. The Rosebud Sioux Wind Project proves that he was right.

Lunderman passed into the Spirit World in 2000, but his legacy lives on. In February 2003, the first utility-scale tribally owned wind turbine, a 750-kilowatt NEG Micon named after Lunderman, was installed on the Rosebud Sioux Indian Reservation, marking the end of eight years of preparation and the beginning of a bright economic future for the tribe.

#### The History

In 1995, the Rosebud tribe, the Tribal Utility Commission, and the Rosebud Casino paid for the installation of an anemometer and began measuring their wind resources. The tribe's wind resource proved to be a Class 5/Class 6 resource, which is considered excellent. This news came as no surprise to members of the tribe—they joke about how the wind always blows on the Rosebud Reservation.

In 1998, the tribe applied for a cooperative grant from the U.S. Department of Energy (DOE) to build a commercial utility turbine. The tribe had 18 months of wind data to back up their request. Working closely with the Intertribal Council on Utility Policy (ICUP) and Distributed Generation, Inc., the Rosebud tribe negotiated the first



Fourth of July powwow at the Rosebud Reservation.

U.S. Department of Agriculture Rural Utilities Service loan to a tribe for a commercial wind energy project.

On May 1, 2003, the Rosebud Sioux held a dedication ceremony. At the dedication, the tribe became the first tribe in the nation to receive a check for the sale of wind power. Their turbine, which can produce more than 2 million kilowatt-hours per year, sometimes generates more energy than the Rosebud Casino can use, so the tribe sells its excess clean energy to Basin Electric for local use, with a multi-year sale of "green power" to Ellsworth Air Force Base. This is possible because of a cooperative effort with Basin, Nebraska Public Power, and the Western Area Power Administration.

The tribe has also negotiated the first tribal sale of "green tags," or renewable energy credits, to NativeEnergy of

— Story continued on page 2



U.S. Department of Energy  
**Energy Efficiency and Renewable Energy**

Bringing you a prosperous future  
where energy is clean, abundant,  
reliable, and affordable

In 2003, the WPA team published its first issue of NAWIG News, the quarterly newsletter of the Native American Wind Interest Group.

excellent wind resources that could be commercially developed to meet their local electricity needs or for electricity export. However, there are several key issues to overcome before these resources can be fully developed. The issues facing wind development on Native American lands include lack of wind resource data, community and local utility authorities and policies, developer risks real and perceived, limited loads, investment capital, technical expertise, and transmission to markets.

To address these issues, WPA provides outreach materials and conducts workshops to provide information about the wind development process and options available to Native Americans. In 2003, WPA conducted several regional workshops for Native Americans and supported the

development of an interactive Native American Wind Interest Working Group (NAWIG) to exchange experiences, concerns, and information on wind development.

To help assess the wind resources on Native American lands, NREL and WAPA offer the Native American Anemometer Loan Program. The program allows Native Americans to borrow anemometers and the equipment needed for installation. Reducing the cost of quantifying their wind resources will encourage more Native Americans to install wind turbines. NREL researchers provide technical assistance for siting, installation, and data analysis. By the end of 2003, 43 anemometers were installed and 23 anemometer projects completed.

The loan of one such anemometer bore fruit on May 1, 2003, when the Rosebud Sioux tribe held a dedication ceremony for the first Native American utility-scale wind turbine. Three weeks later, the Rosebud Sioux became the first tribe in the nation to receive a check for the sale of wind power from its 750-kW turbine. The tribe sells its excess energy to Basin Electric for local use and has a multi-year agreement for the sale of green power to Ellsworth Air Force Base. The sale of green power was made possible through a cooperative effort with Basin, Nebraska Public Power, and WAPA. The tribe has also negotiated the first tribal sale of green tags, or renewable energy credits, to NativeEnergy of Vermont.

During the last week of October, the NWTC hosted the annual Wind Energy Application and Training Symposium. Members of Native American tribes with anemometer loans, current or pending Tribal Energy Program grants, or reservations located in windy areas were among the invited participants.

#### Creating a Sustainable Future

The installation of the Rosebud turbine is the first of a three-phase Tribal Wind Power Demonstration Project Plan, a revitalization plan for intertribal wind development sponsored by the Rosebud Sioux tribe and Intertribal Council on Utility Policy (ICUP).

Native American reservations on the northern Great Plains possess a tremendous wind resource, estimated to exceed 700 GW. To put that in perspective, the installed energy generation capacity of the entire United States from all sources of energy is about 600 GW. This incredible wind resource can help revitalize tribal communities and economies across the Northern Great Plains through the development of large, utility-scale renewable energy



generation. Intertribal COUP's plan for the Great Plains tribes would bring at least 3,000 MW of power to market in the next decade.

Phase 2 will include the installation of a 30- to 50-MW wind ranch on the Rosebud Reservation. The tribe has already received a DOE grant for planning and has completed feasibility studies for potential projects based on anemometer studies. Phase 2 also involves assisting every ICOPU tribe in the region interested in wind development with the data collection necessary to formulate a business plan.

Phase 3 involves an 80-megawatt project distributed across eight reservations (10 megawatts apiece) in North and South Dakota. This distributed generation will allow the actual loads on each reservation to be met, and allow for parts of the project to supply wind to the grid most of the time.

Later phases of the project include plans for expanding wind farms on tribal lands while helping the tribes realize sustainable economic development and employment. ♦



In May 2003, the Rosebud Sioux tribe dedicated the first Native American utility-scale wind turbine on their reservation in South Dakota.

# WIND POWER TOMORROW

## Fueling the Future with Wind



While the wind industry has experienced constant annual growth during the past decade, to achieve industry's 100 GW goal and enable the technology to reach its full potential, DOE researchers are exploring innovative applications like offshore deepwater development, the use of wind energy to clean and move water, and developing new technologies that will enable wind energy to work in synergy with other energy technologies such as hydropower and hydrogen.

### Offshore Wind Developments R&D Priorities and Exploring the Potential Resource

Higher-quality wind resources (reduced turbulence and increased wind speed), proximity to loads (many demand centers are near the coast), increased transmission options,

potential for reducing land use and aesthetic concerns, and ease of transportation and installation are a few of the compelling reasons researchers are turning their attention to offshore development. Although there are no current offshore wind installations in the United States, there are several proposed applications for offshore projects along the East Coast from New England to the Virginia.

For offshore turbines in very shallow water (5–12 m [16.4–39.4 ft]), European turbine manufacturers have adopted conventional land-based turbine designs and placed them on concrete bases, steel mono-piles, or truss support structures and anchored them to the seabed. An offshore substation boosts the collection system voltage, and a buried undersea cable carries the power to shore, where another substation provides a further voltage increase for transmission to the loads.



Although the same approach can be used for wind turbines installed off the East Coast, the wind, wave, tide, and current design conditions are thought to be more severe in the United States and less well defined than for the Baltic and North Seas. In addition, the turbine structural dynamics and fatigue loadings of offshore machines are much more complex and difficult to analyze than for turbines on land. Thus, researchers will need to conduct supporting R&D to validate the turbine designs and reduce the risks. Offshore projects must be larger in terms of both turbine size and project scale to support the costs of the added turbine seabed support structures and cabling. These factors will tend to make financing offshore projects commensurately more difficult until offshore wind technology has proven its viability and profitability to investors.

In 2003, DOE initiated a research effort to assess the potential for offshore wind development in the United States, including resource assessments and technical workshops for a broad range of stakeholders. Meso-scale modeling used to determine the onshore wind resource for many

coastal states has provided preliminary estimates of wind resources out to 50 nautical miles (nm) offshore for recently mapped regions of the United States. These estimates indicate that the East Coast has 38 GW potential in water shallower than 30 m (98.4 ft) and 20–50 nm offshore that may be harvestable using, strengthened versions of today’s land-based turbines adapted for marine environments. The more than 600 GW of estimated offshore wind resource in water 30–100 m (98.4–328 ft) and deeper would require new technologies that allow deepwater development, but would open vast areas out of sight of land for electric power generation. NREL will lead an effort to develop a series of coastal maps that indicate offshore wind resources in the Northeast, Mid-Atlantic, Great Lakes, and Gulf of Mexico.

The U.S. Army Corp of Engineers currently serves as the lead agency for permitting offshore wind structures. Several applications have been received for permitting offshore wind projects and have increased interest and media attention on the offshore markets. In addition, regulators at the state and federal levels have requested guidance

## New England Offshore Wind Resource Potential

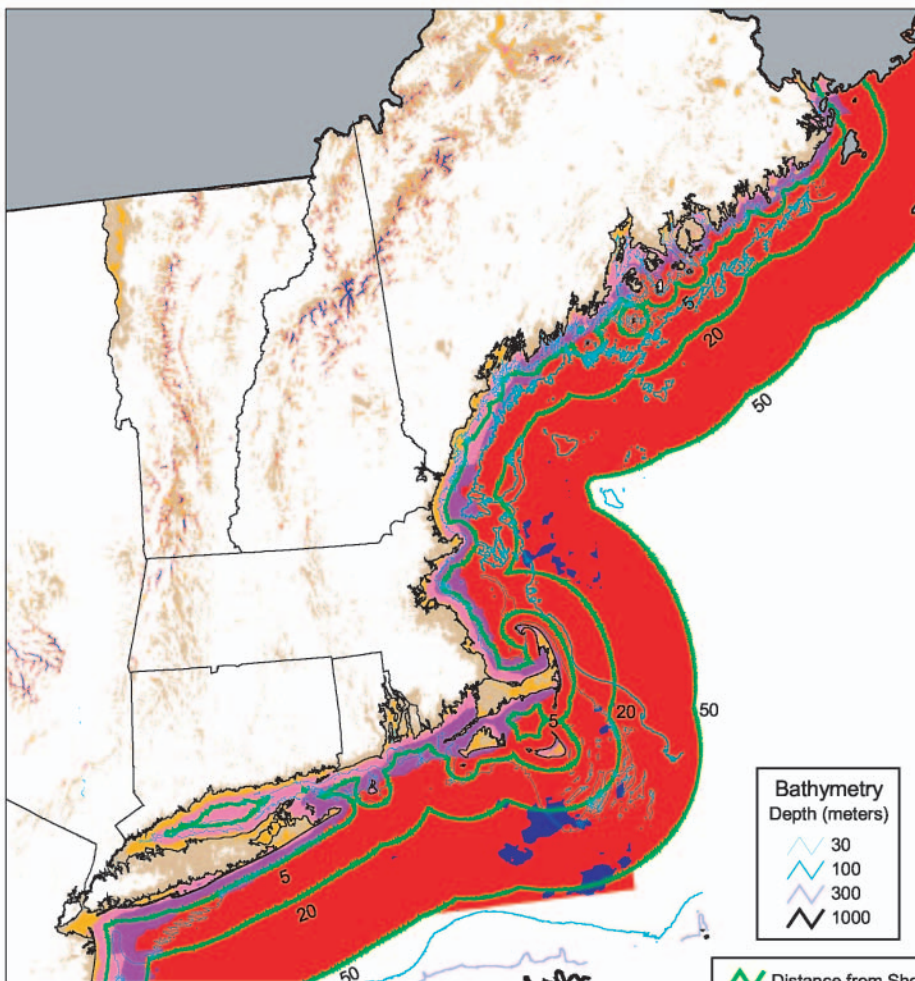

All areas > 5 nautical miles offshore likely to be class 4 resource or better.

Area 5-20 nautical miles from shore (67% excluded):  
 10,300 sq. km. (51,500 MW)  
 1,980 sq km (9,900 MW) <30m depth

Area 20-50 nautical miles from shore (33% excluded):  
 33,800 sq. km. (169,000 MW)  
 540 sq km (2,700 MW) <30m depth

The wind power resource data for this map was produced by TrueWind Solutions using the Mesomap system and historical weather data, and has been validated by NREL.

The bathymetry contour lines were derived from NOAA's coastal relief models (nominal resolution 1 km) from NOAA's National Geo-physical Data Center.

Wind Power Classification				
Wind Power Class	Resource Potential	Wind Power Density at 50 m W/m <sup>2</sup>	Wind Speed <sup>a</sup> at 50 m m/s	Wind Speed <sup>a</sup> at 50 m mph
2	Marginal	200 - 300	5.6 - 6.4	12.5 - 14.3
3	Fair	300 - 400	6.4 - 7.0	14.3 - 15.7
4	Good	400 - 500	7.0 - 7.5	15.7 - 16.8
5	Excellent	500 - 600	7.5 - 8.0	16.8 - 17.9
6	Outstanding	600 - 800	8.0 - 8.8	17.9 - 19.7
7	Superb	> 800	> 8.8	> 19.7

<sup>a</sup> Wind speeds are based on a Weibull k value of 2.0

U.S. Department of Energy  
 National Renewable Energy Laboratory



## Offshore Potential for Non-European Union Countries

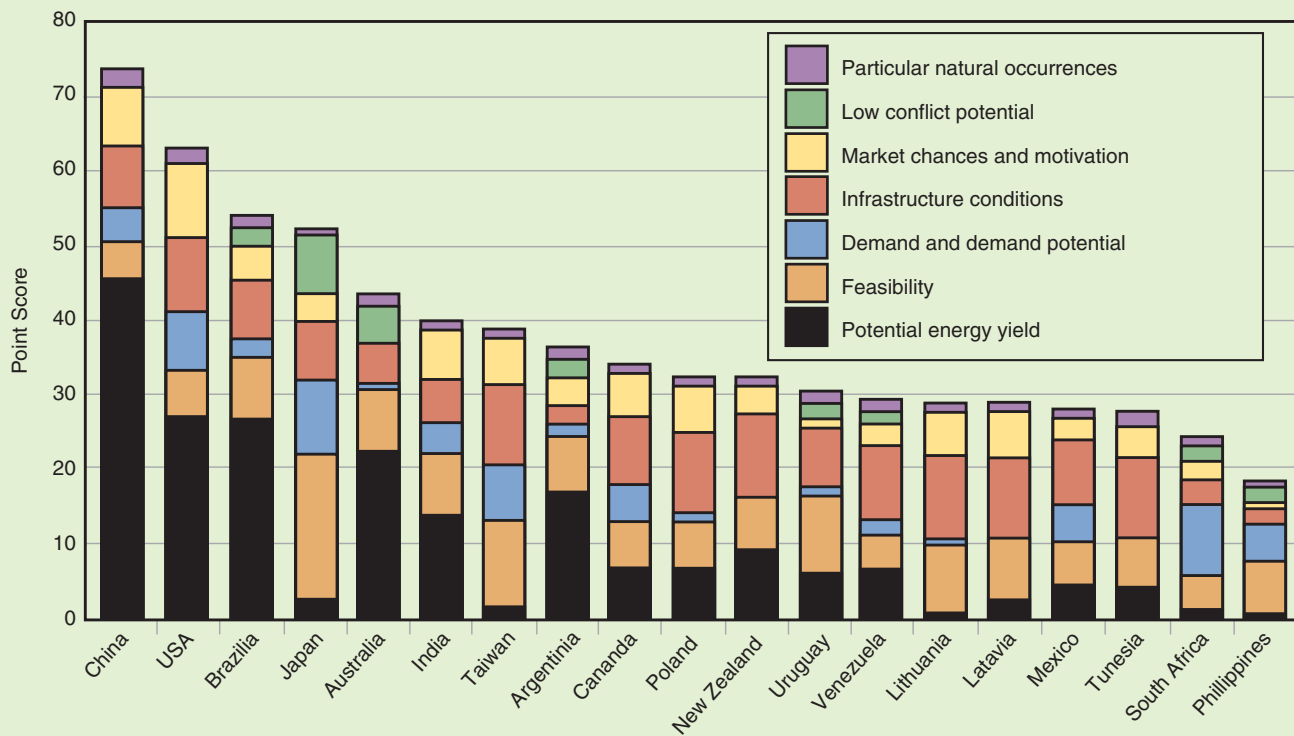

Reference: S. Siegfriedsen, M. Lehnhoff, & A. Prehn, aerodyn Engineering, GmbH  
 Conference: Offshore Wind Energy in the Mediterranean and other European Seas, April 10-12, 2003, Naples, Italy

and information from DOE, as this is their first experience with permitting offshore wind energy systems. In response to this request, NWCC organized a dialogue on offshore wind energy in the United States in July 2003. This workshop brought together a range of stakeholders, including government officials, environmental groups, and interested citizens. The participants discussed the potential for offshore wind resources, the priorities for DOE, regulatory and jurisdictional issues, and the stakeholder process for the Cape Wind project. Visit the NWCC Web site for these presentations and a meeting summary at <http://www.nationalwind.org/events/offshore/030701/default.htm>

In response to recommendations made at the meeting, the program organized a technical tutorial for regulators and other government officials involved with permitting proposed projects in New England. In September 2003, DOE and its Boston Regional Office held a workshop for 65 state and federal government representatives in Boston. The presentations focused on wind energy technologies, including engineering principles, technology status, and operational characteristics, both on- and offshore. The U.S. Coast Guard, Federal Aviation Administration, and other federal partners discussed their rules, and the processes that apply to wind facilities. On the second day, the National Park Service held a briefing on alternative energy developments around the Boston Harbor Islands, and the participants visited Hull,

Massachusetts, where the local municipal utility currently operates one 660-kW Vestas wind turbine and is considering plans to increase wind capacity in the future (see <http://www.hullwind.org/>).

DOE believes that one research area with promise for the United States is offshore wind projects in waters deeper than 30 m (98.4 ft). Other nations with long coastlines, but without extensive areas of shallow seas within their continental shelves, would benefit from technological developments favoring deeper water offshore installations. Of the nations that show a significant potential for the use of offshore energy, China and the United States have the highest potential, followed by Brazil and Japan.

In October 2003, DOE and NREL held a workshop in Washington, D.C., to discuss deep water technologies with about 50 U.S. and European experts in wind engineering, oil and gas structures, and marine measurements (see [http://www.nrel.gov/wind\\_meetings/offshore\\_wind/](http://www.nrel.gov/wind_meetings/offshore_wind/)).

Participants identified significant engineering challenges, including the downsizing of oil and gas platforms by two orders of magnitude while designing for turbine dynamic inputs. The findings included:

- The oil and gas technology communities have strong analytic and computational resources that can serve as resources for the wind engineering community.



- There is a general consensus that economical, floating offshore applications are achievable.
- The next steps include obtaining environmental data needed to characterize operating conditions; developing models to understand system dynamics; and determining whether the turbine and platform can be dynamically modeled separately.

The Office of Wind and Hydropower Technologies continues to evaluate the resources available and investigate offshore wind development opportunities. In 2003–2004 the Phase II low wind speed technology (LWST) solicitation was expanded to include offshore concepts, components, and full systems. Another research effort focuses on tracking projects and studies in Europe, where offshore demonstration projects have been operating for the last decade. Findings from marine and avian studies that may address our domestic environmental research concerns, e.g., methodological approaches, will be summarized and made available to a broad regulatory community involved with assessing environmental effects and permitting offshore wind facilities. NREL continues to serve on international committees such as the International Standards Organization, International Energy Agency (IEA), and the International Electrotechnical Commission (IEC) (e.g., drafting design requirements for offshore wind turbines). These efforts will contribute to defining more specifically how DOE will continue to support and promote offshore wind energy.

## Wind and Water Working Together

While fluctuating power levels and transmission constraints may hamper ready adoption of wind energy to utility grids, fluctuating regional water resources, growing obligations and market pressures on water uses (need for flood controls, environmental issues, and recreation) are just a few constraints faced by the hydropower industry. Researchers have long postulated that wind and hydropower can work together to mutual benefit, but no detailed analyses to examine regulation,

load following, reserve, and unit commitment generator and grid operations have been conducted. Most experts agree that the value of wind and hydropower could be mutually enhanced by working together. For example, variations in power delivery levels caused by natural wind speed changes could be damped or eliminated. Hydro facilities might act as “batteries” for wind power by storing water during high wind periods, and increasing output when wind power goes down. Similarly, periods of low water resources or policy pressures on water use can be mitigated by using wind to generate power normally generated by the hydropower systems.

In addition to exploring the opportunities for wind and hydropower to work together to produce a stable supply of electricity, researchers are examining ways wind can help resolve conflicts that surround fresh water uses. Other potential wind/water applications include the use of wind energy to clean water used for oil and gas exploration processes, provide power for municipal wastewater treatment, and provide power for irrigation systems.



Wind technologies workshop participants visited the turbine owned by Hull Municipal Lighting Plant in Hull, Massachusetts. This turbine provides enough electricity to power the street lights of Hull.

DOE initiated the exploration of the possible synergy between wind and hydropower resources in November 2003 when it sponsored an IEA R&D Wind Annex XI Topical Expert Meeting on the Integration of Wind and Hydropower Systems. Hosted by BPA in Portland, Oregon, the meeting drew 28 energy experts from the United States, Canada, Norway, and Sweden. The participants delivered 15 presentations that ranged from high-level national perspectives on wind/hydropower integration to details of specific wind/hydropower projects. The main topic was whether wind and hydropower technologies can work together to provide a stable supply of electricity to an interconnected grid.

Although no formal decision was made, the formation of an IEA wind/hydropower integration R&D annex is being seriously considered.

In the meantime, DOE is conducting analyses of specific potential and actual generation projects and full watershed basin/electric control areas. The cooperation of federal power management agencies such as BPA, WAPA, and Tennessee Valley Authority will be integral to the work.

## Using Wind and Hydropower to Produce Hydrogen

Researchers are also looking at both wind and hydropower—two of the lowest cost renewable energy resources—to help produce yet another renewable energy source—hydrogen. According to a report recently released by the National Research Council (NRC), “A transition to hydrogen as a major fuel in the next 50 years could fundamentally transform the U.S. energy system, creating opportunities to increase energy security through the use of a variety of domestic energy sources for hydrogen production while reducing environmental impacts, including atmospheric CO<sub>2</sub> emissions and criteria pollutants.” The report recommends that DOE focus its research on distributed natural gas and wind-electrolysis to enable this transition within the next two decades.

As one of the most cost-competitive renewable energy technologies available today, wind energy has the greatest potential for producing pollution-free hydrogen. It fulfills two main motivations propelling the current push toward a hydrogen economy;

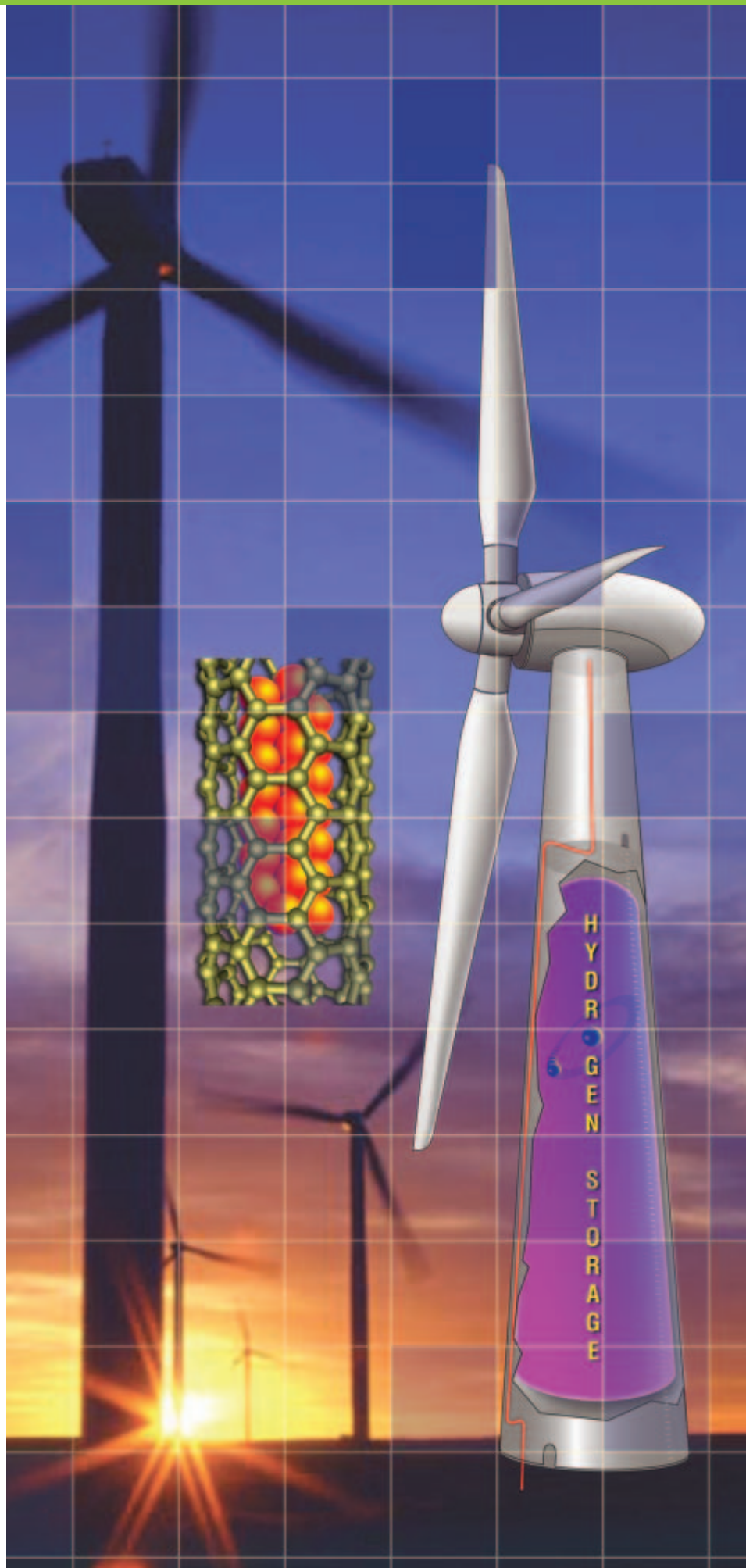



reducing CO<sub>2</sub> emissions and reducing the need for hydrocarbon imports. In September 2003, DOE hosted a workshop to bring together stakeholders from the wind, hydropower, and electrolysis industries to explore the potential for cost-effective electrolytic production of hydrogen from wind and hydropower. Fifty-three participants, representing wind turbine manufacturers, electrolyzer manufacturers, hydropower generation facilities, utility companies, research institutes, national laboratories, trade and public interest associations, consulting research firms, and DOE, attended the workshop. The key goals were to:

- Start a dialogue among industry stakeholders on key opportunities and potential technology synergies.
- Review and gather industry feedback on current modeling and analysis efforts funded by DOE on the potential for coproduction of electricity and hydrogen from wind and hydropower.
- Obtain industry input on key challenges to electrolytic production of hydrogen from wind and hydropower and the R&D activities needed to address these challenges.

Participants agreed to continue and expand the dialogue on hydrogen production with a larger group while DOE considers the formation of an industry working group that will develop recommendations for future activities. NREL researchers agreed to incorporate the recommendations they received from industry members in their modeling efforts. DOE may schedule a second workshop in 2004 to provide more detail on the opportunities, challenges, and R&D needs associated with electrolytic production of hydrogen from wind and hydropower.

## Opening Federal Lands to Renewable Energy Production

Another option for increasing the deployment of renewable energy technologies is to develop federal lands. The federal government controls nearly 263 million hectares (650 million acres), or about 28% of the land in the United States. It controls more than half the land in the western part of the country (more than 60% of Utah and 80% of Nevada). Approximately 96% of federal land is administered by four federal agencies. The agencies with the largest land holdings are the Bureau of Land Management (BLM), the National Forest Service (NFS), the Fish & Wildlife Service (USFWS), and the National Park Service. Nearly 8 million hectares (20 million acres) are administered by DOD, making it the fifth largest federal land manager.

Although large tracts are set aside for wilderness areas, wildlife refuges, and parks, a huge amount of federal land is still available for development. Because of their very different missions, the various federal land management agencies have widely differing procedures for permitting the lands for wind energy development. The agencies of most interest to wind developers are BLM, DOD, and NFS. Except for



The Department of Defense is taking a leadership role in examining the use of renewable energy on land under its jurisdiction, like this wind turbine on a Navy base on San Clemente Island.

showcase wind turbines at visitor centers and similar small wind applications, the lands administered by the USFWS and the National Park Service lands are not likely to be used for development.

To date, the Department of Interior's BLM has led the way to open domestic resource areas for responsible development. In 2001, the Secretary of the Interior directed the department to examine the procedures for permitting new energy projects on lands under its administration. The BLM has since moved aggressively to streamline its permitting procedures and has used wind as the pilot technology. In a few months, permit applications for wind prospecting and wind project development on BLM lands have increased from a small handful to more than 150. In addition, BLM is undertaking a programmatic environmental impact

statement for wind energy on BLM lands with support from Argonne National Laboratory and NREL.

The Department of Defense is also taking a leadership role in examining renewable resources on lands under its jurisdiction. In FY 2002, the Military Construction Bill contained a set-aside of \$6 million for studying renewable energy potential (wind, solar, and geothermal) on or near military bases in the United States. DOD bases with the best potential for economically viable wind energy projects will be identified and a list of bases will be published. Meanwhile, individual bases with extensive land areas and good wind potential can be approached individually to explore the possibility of commercial wind energy development. Successful projects can not only avoid interference by private developers with the base's mission, but also serve as innovative options to financially compensate the local military units. (Funds from traditional land leases go directly to the U.S. General Fund, not to the base.)

The USDA's Forest Service has also expressed a willingness to follow a procedure similar to that used by BLM to identify lands for wind energy development and ease the permitting process.

The National Park Service held an Energy Summit in Phoenix, Arizona, in January 2003. Its purpose was to raise awareness and provide education about:

- Energy development activities in and around park units in the western United States (including extraction, processing, transmission, and generation)
- Potential impacts and impact reduction strategies of energy development
- Planning and decision-making processes
- Opportunities for reducing energy consumption.

The summit targeted park superintendents and management chiefs from the 10 western United States.

Finally, the Department of Interior's Fish and Wildlife Service has developed a draft report titled Fish & Wildlife Service Voluntary Siting Guidelines for wind development on lands they administer. A copy of the report may be downloaded at: [http://www.nationalwind.org/workinggroups/wildlife/summaries/fws\\_030729.pdf](http://www.nationalwind.org/workinggroups/wildlife/summaries/fws_030729.pdf) . ♦





# THE FEDERAL WIND AND HYDROPOWER TECHNOLOGIES PROGRAM

DOE's Wind and Hydropower Technologies Program conducts research to advance the development of two of this nation's greatest renewable resources—wind and water. On the hydropower side, the program conducts research to help industry develop turbines with increased efficiencies that are more environmentally compatible. On the wind side, the program works with industry to decrease the COE and develop technologies that will work in the lower wind speed areas.

The mission of the Wind Energy Program is to support the President's National Energy Policy and departmental priorities for increasing the viability and deployment of renewable energy; lead the nation's efforts to improve wind energy technology through public/private partnerships that enhance domestic economic benefit from wind power development; and coordinate with stakeholders on activities that address barriers to use of wind energy. The goals of the Wind Energy Program include:

- Reduce the cost of wind energy for onshore low wind speed sites (Class 4) to \$0.03/kWh and \$0.05/kWh for offshore sites by 2012.
- Reduce the cost of electricity from distributed wind systems to \$0.10–\$0.15/kWh in Class 3 wind resources, the same level that is currently achievable in Class 5, winds by 2007.

- Complete program activities that address electric power market rules, interconnection impacts, operating strategies, and system planning needed for wind energy to compete without disadvantage to serve the nation's energy needs by 2012.
- Facilitate the installation of at least 100 MW in 30 states by 2010.

To accomplish these goals and support the program mission, two of DOE's principal research laboratories, NREL and Sandia National Laboratories (SNL), work with private industry partners and researchers from universities nationwide to develop advanced wind energy technologies.

Each laboratory is extensively equipped with a unique set of skills and capabilities to meet industry needs. NREL's National Wind Technology Center (NWTC) near Boulder, Colorado, is designated as the lead research facility for the wind program. The NWTC conducts research and provides its industry partners with support in design and review analysis; component development; systems and controls analysis; structural, dynamometer, and field testing; certification; utility integration; resource assessment; subcontract management; and outreach. SNL, based in Albuquerque, New Mexico, conducts research in advanced manufacturing, component reliability, aerodynamics, structural analysis, material fatigue, and control systems.

The Wind Energy Program focuses its research in two areas: technology viability and technology application. Under technology viability, researchers work with industry members to increase efficiencies and reduce the COE for utility-scale and small, distributed wind systems for low wind speed regions. Under technology application, researchers work to improve technology acceptance and utility grid integration while providing engineering support and testing.

## Technology Viability

### Low Wind Speed Technology

The goal of the low wind speed R&D is to reduce the cost of wind energy for onshore low wind speed sites (Class 4) to \$0.03/kWh and \$0.05/kWh for offshore sites by 2012. To meet this goal, researchers at NREL and SNL are working with industry partners to design, build, test, and refine advanced turbine prototypes and components that will lead to greater deployment of wind energy.

Industry partnerships are formed through cost-shared technology development subcontracts. These subcontracts

concentrate on three technical areas: 1) concept design studies, 2) component development and testing, and 3) full turbine prototype development and testing. The funding provided by the program enables industry to develop high-risk, advanced wind technology that it would not be able to fund on its own and explore the effects of increased turbine size on performance and cost.

### Distributed Wind Technology

The goal for distributed wind technology is to reduce the cost of electricity from distributed wind systems to \$0.10–\$0.15/kWh in Class 3 wind resources, the same level that is currently achievable in Class 5 winds, by 2007. As with the research conducted for the large low wind speed turbines, researchers will work with industry partners to develop prototypes and components to increase efficiencies and lower costs, thus leading to widespread commercial development and acceptance.

Small wind turbines can be combined with solar electric systems, diesel generators, micro gas turbines, and batteries to form powerful hybrid systems that can power ranches or small villages. These hybrid systems have great potential in the developing world market and in rural areas of the United States. Small wind turbines can also be connected to the utility grid, contributing to our nation's energy mix and helping consumers offset their utility bills. The industry estimates that small wind turbines could meet 3% of our nation's electricity consumption by 2020.

### Supporting Research and Testing

The NWTC and SNL provide a wide range of research and testing services to support its industry partners in developing utility-scale and distributed low wind speed systems. These activities bring specialized technical expertise, comprehensive design and analysis tools, and unique testing facilities to bear on problems that industry will encounter in bringing the new wind technology to the marketplace. Program researchers may contract with universities and other research organizations to complement the services provided by the two laboratories.

### Enabling Research

Wind turbine performance can be increased and costs reduced through near-term research that leads to incremental improvements as well as long-term, enabling research that will help industry achieve DOE's cost reduction goals. Enabling research is conducted in site-specific design; advanced rotor development; generator, drivetrain, and power electronics efficiency improvements; systems and controls; and design review and analysis.

### Advanced Rotor Development

To meet the low wind speed goals, researchers will need to design larger, lighter weight rotors with longer blades to sweep greater areas for improved energy capture and keep costs to a minimum. Advanced rotor R&D is being conducted in blade development, aerodynamic code development and validation, and aeroacoustics research and testing.



The prototype for GE Wind Energy's 1.5 MW turbine was developed in cooperation with DOE's Wind Energy Program.





Researchers at NREL and Sandia are working to develop larger, lighter weight rotors with longer blades to sweep greater areas for improved energy capture and keep costs at a minimum.

**Blade Development** — To design longer blades that can sweep greater areas for improved energy capture, researchers are analyzing the use of stronger, lighter weight materials and improved blade designs. At SNL, researchers are developing tools to better predict how these new materials will interact with component parts of turbines and react to high loads, especially from infrequent high wind gusts. The performance of composite materials, especially resin systems and carbon and carbon/glass hybrids, is a special focus of this research. SNL is also working to develop nondestructive testing techniques for the materials, and the laboratory maintains a test site for wind turbine components at the USDA's Agricultural Research Service in Bushland, Texas.

**Aerodynamics** — Because low wind speed turbines will be larger and lighter weight than previous models, they may be more vulnerable to material fatigue. Predicting how they will interact with the turbulent wind patterns at greater heights is difficult. To understand wind turbine aerodynamics, researchers at NREL and SNL are combining two-dimensional field and wind tunnel test data to predict aerodynamic loads on turbines under varied inflow conditions. To improve the predictive power of these analyses, researchers are adapting a more accurate approach used for helicopter and aircraft design. Their evaluations will be based on analyses of three-dimensional computations of fluid dynamics.

**Aeroacoustics** — As large wind turbines move closer to load centers that are more densely populated and small turbines become more popular in residential areas, developing turbines that operate quietly is becoming more important. Wind turbine noise can be caused by rotor speed, blade shape, tower shadow, and other factors. Researchers at the NWTC and SNL are using wind tunnels and conducting field tests to develop an airfoil that will reduce turbine noise. They are also working with industry to develop a noise standard that can be used by the growing domestic market for small wind turbines.

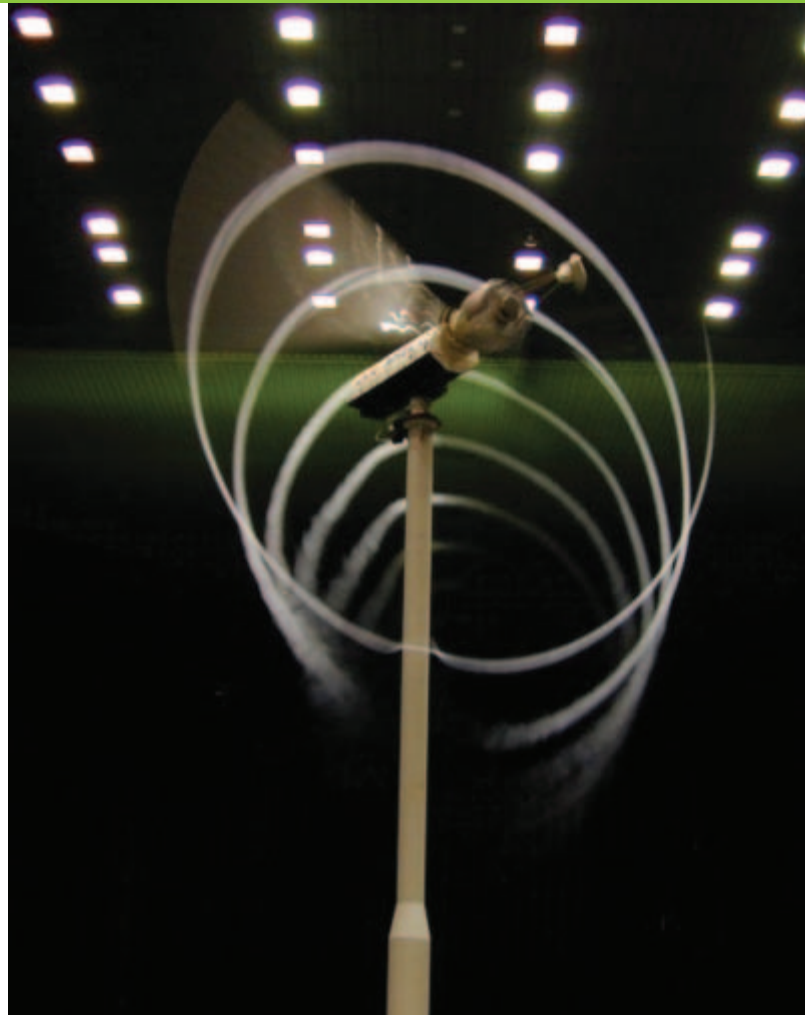

To understand wind turbine aerodynamics, researchers at NREL and SNL are combining two-dimensional field and wind tunnel test data to predict aerodynamic loads on turbines under varied inflow conditions.

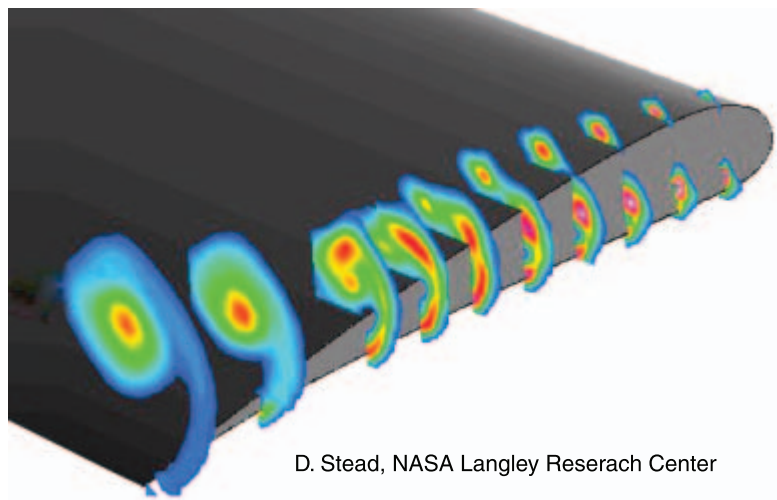

D. Stead, NASA Langley Research Center

Computational Fluid Dynamics (CFD) and Computational Aeroacoustics (CAA) Codes are being developed to analyze airfoil and rotor acoustic emissions.

## Site-Specific Design

To develop this nation's vast low wind speed resources, researchers must better understand the different environments in which the turbines will operate. Whether they are located in Midwestern cornfields or in the waters off the eastern shoreline, multimegawatt advanced low wind speed turbines will operate on very tall towers and will encounter environmental elements that may damage rotors and limit energy capture and operational lifetime. To design efficient turbines that can withstand these loads, researchers need to analyze the nature of atmospheric loading. Once they understand the nature of the environment in which a turbine operates, they can optimize system design to create site-specific designs that ensure maximum performance and control costs. Turbines located at high energy sites with greater turbulence (and hence greater system loads) require heavier, more durable materials that cost more to produce. Turbines located at lower energy sites would cost less because their designs would incorporate lighter weight, less expensive materials. Site-specific research is conducted in inflow characterization and design load specifications.

**Design Load Specifications** — In addition to improving performance and reducing costs, site-specific design research can be used to develop load specifications for design standards. Such standards will help prevent catastrophic failure and ensure quality, production, and safe operation.

**Inflow Characterization** — On the Great Plains, where there is an abundance of the low wind speed resources, wind patterns called nocturnal jets form closer to the ground at night. Very little is known about the turbulent wind patterns associated with those nocturnal jets. To design efficient turbines that can withstand this higher

altitude turbulence, researchers are developing more accurate simulation models on which they can base their designs. Design and performance codes are being improved leading to new components and architectures that reduce structural loads while increasing performance and energy output.

To understand the turbulent, higher altitude wind patterns, researchers at the NWTC and SNL are gathering data from tall towers, test turbines, a state-of-the-art Doppler acoustic wind profiler, and laser wind speed measurement remote sensing systems. By combining the data provided by the different measurement systems at different locations, researchers can improve their design simulation capabilities to include conditions at the heights where the larger wind turbines need to operate reliably.

## Generator, Drivetrain, and Power Electronics Efficiency Improvements

The generator, drivetrain, and power electronics are major components of a wind energy system. They represent about 25% of the installed capital cost and are responsible for converting the mechanical energy into electrical energy and conditioning that electrical energy so it can be fed into the utility grid. As wind turbines become larger, generator and gearbox weight becomes an increasingly critical factor that affects other system components and installation costs. Thus, traditional generator designs may not be cost effective for the next generation of wind turbines.

Future designs of generators and power converters are likely to be specialized and tailored to wind turbine operation. Use of permanent magnet generators that are more compact and have higher flux densities will be important for future designs. Power converters and generators that allow variable speed operation and have higher efficiencies at or below rated power will also be important contributors to future operation.

## Systems and Controls

As today's low wind speed systems become taller and more flexible, researchers are investigating the means to mitigate system fatigue by gaining better control of the way the components interact and move. Control systems that regulate turbine power and maintain stable closed-loop behavior in the presence of turbulent wind inflow are also critical for these LWST designs. The objective of the systems and controls research is to increase energy capture and reduce structural loading for minimal cost. To achieve these goals, researchers are studying conventional turbine component controls such as blade pitching, new components such as twist-coupled blades, and advanced devices such as micro-tabs. Researchers are also developing innovative hub control strategies to reduce aerodynamic loads at the rotor hub and investigating ways to improve control system codes.

**Design Codes** — To accurately predict the behavior of new design concepts, accurate design codes will be needed to produce realistic models that simulate the behavior of a wind turbine in complex environments—storm winds,

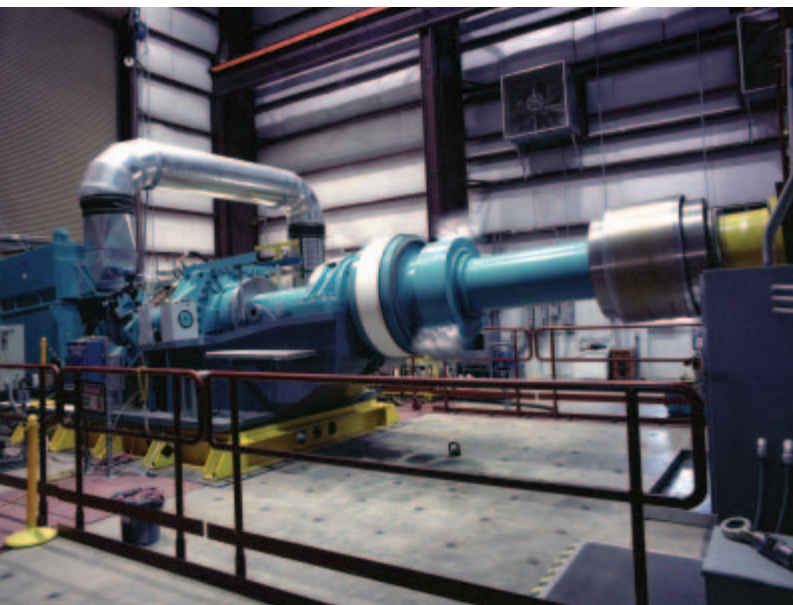

A 1.5 MW wind turbine drivetrain manufactured by GE Wind undergoes a lifetime duration test on the NWTC's 2.5 MW dynamometer test stand.



waves offshore, earthquake loading, and extreme turbulence.

Current simulation codes developed over the past 10 years can model the effects of turbulent inflow, unsteady aerodynamic forces, structural dynamics, drivetrain response, and control systems. To further reduce the cost and risk of production to manufacturers, researchers have established a short-term goal of increasing code accuracy and reducing modeling uncertainty. Researchers are working to isolate the source of modeling uncertainties in current codes and develop methods for improving the accuracy through code validation and model tuning. For future advanced design concepts, researchers have set a long-term goal of predicting turbine response and loads to within 15% accuracy.

### University Research

To increase the base of scientific and technical knowledge of wind energy and develop centers of wind energy research excellence, DOE's Wind Energy Program forms partnerships with universities and educational institutions nationwide. NREL and SNL support this effort by awarding multiyear university research subcontracts in areas of special interest and value to the program. Partnering with universities also enhances graduate research training opportunities to develop highly qualified scientific and engineering personnel to meet future national needs in wind and other energy fields.

### Design Review and Analysis

NREL and SNL evaluate the adequacy and safety of engineering designs explored in each subcontract, offering a wide range of tools to help companies solve problems and meet project deadlines. The program collaborates with Underwriters Laboratories (UL) on design review and testing for UL certification of wind turbines and wind turbine components for large and small machines.

### Testing Support

Wind Energy Program researchers work with industry members to verify wind turbine performance, design loads, and reliability by testing turbine components and full-scale turbines in laboratory environments and in the field. Resulting test data can then be used to validate turbine design codes and simulations to further advance turbine designs.

### Field Testing

Field testing encompasses a wide range of activities that provide high-quality testing to support LWS and distributed wind technology projects. Such testing is typically conducted on full-scale wind turbine systems installed in the field, although it sometimes targets specific components and subsystems, and includes tests performed according to international standards and to support turbine R&D. Field tests measure turbine loads, acoustic emissions, power production, power quality, and safety and function.

Accredited turbine field data are essential inputs to design evaluations required to support certification and

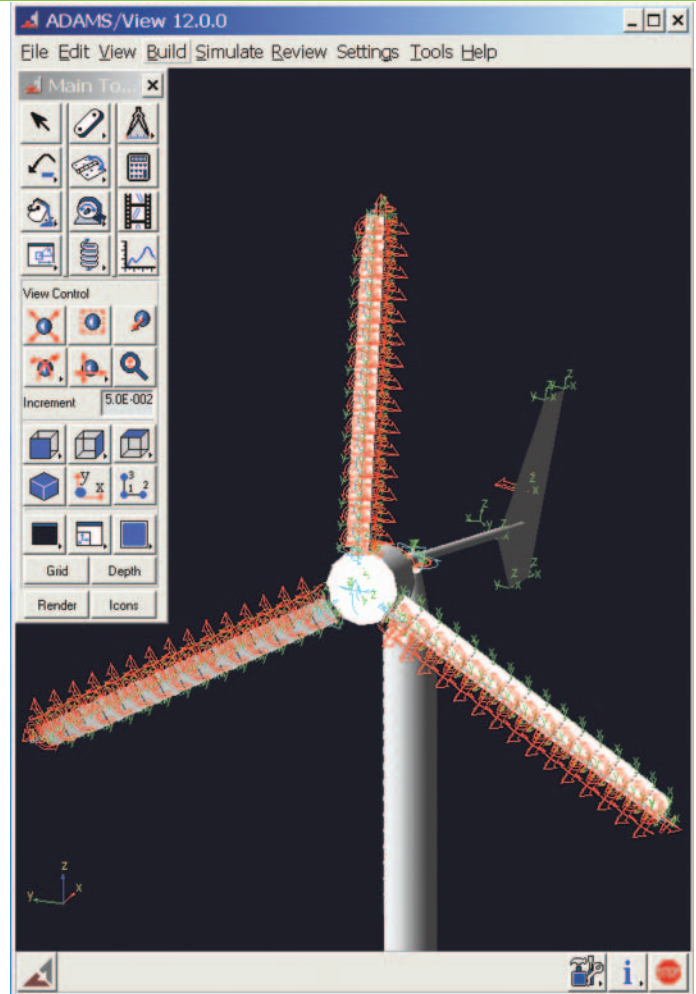

This graphic of a furling turbine is from the commercial ADAMS design code; one of the simulators used to model wind turbines at the NWTC. The red arrows on the graphic indicate the locations at which aerodynamic forces are applied to the wind turbine blades.

due diligence activities. For wind turbines to be successful in the domestic and international marketplaces, they must meet international standards for reliability and must be certifiable by an internationally recognized agency.

### Structural Testing

Researchers at the NWTC structural test facility conduct structural tests on full-scale wind turbine blades for sub-contractors and industry partners. The facility's capabilities include fatigue testing, ultimate static strength testing, and several nondestructive techniques, such as photoelastic stress visualization, thermographic stress visualization, and acoustic emissions.

In 2005, the Wind Energy Program plans to begin construction on a new 70-m structural blade test facility with a 22,500 square foot high bay. The new facility will house two 50-ton gantry cranes, and a 35,000,000 foot-pound test bed to conduct stress tests on blades, and administrative support, utility/test, and support/observation spaces.

### Dynamometer Testing

NREL's 2.5-MW dynamometer is used to conduct a range of wind industry system tests that cannot be duplicated in



Researchers at the NWTTC conduct a fatigue test on a 37-m blade.

the field. Tests conducted on the dynamometer include gearbox accelerated gear life, lubrication, and wear; wind turbine control simulations; transient operation; and generator and power system component efficiency and performance. Before NREL's dynamometer facility was completed in 1999, the only way to verify operating integrity was to test a field prototype under severe conditions. The facility provides improved methods for full-system testing of wind turbine systems to identify critical integration issues before field deployment. The facility gives the U.S. industry an edge over strong European competition because it is the only facility of its kind in the world.

To support industry's need to test drivetrains larger than 2 MW, the Wind Energy Program has plans to start construction on an 8-MW dynamometer facility in 2005 with an expected completion date in 2008. The new facility, currently under consideration, will verify gearbox design conditions, evaluate new low-speed PM direct-drive generators, and test innovative power electronic devices for low wind speed turbine technology.

## Technology Application

### Systems Integration

With rising electric demands, more utilities are evaluating wind power to provide part of their generation mix. At the same time, many utilities are seeking to understand possible

impacts on system operations when a large amount of wind power is introduced into the electric power system. Their concerns, if not adequately addressed, could significantly limit the development potential of wind power in this country.

Wind Energy Program researchers are assisting industry partners with a number of projects to help them characterize integration issues and increase utility confidence in the reliability of new wind turbine products. Information gained from the projects will be distributed through a national outreach effort to investor-owned utilities, electric cooperatives, public power organizations, and energy regulators to enable them to properly consider the inclusion of wind power in generation portfolios and ensure the continued role of wind energy in utility planning.

### Resource Assessment

One of the first steps to developing a wind energy project is to assess the area's wind resources. Correctly estimating the energy available in the wind can make or break the economics of a project.

To provide the best information possible, DOE's Wind Energy Program developed a computerized mapping system that produces high-resolution wind maps.

The maps have a resolution of 1 km<sup>2</sup> (.386 mi<sup>2</sup>), in contrast to the old maps that have a resolution of 25 km<sup>2</sup> (9.7 mi<sup>2</sup>). Using a geographic information system, researchers can add overlays of significant features, such as power lines, park boundaries, and roads to the wind resource maps. Although the program will continue to conduct resource assessment activities to collect the valuable data needed to validate the maps, in 2003, the program began the process of transferring this level of mapping technology to the private sector where a small number of companies can provide mapping services.

### Technology Acceptance

DOE's Wind Powering America is a regionally based set of activities established to increase the nation's domestic energy supply by promoting the use of wind energy technologies, such as low wind speed technology. WPA's objectives are to increase rural economic development, protect the environment, and enhance the nation's energy security. The goal of this initiative is to increase the number of states with at least 100 MW of wind capacity to 30 by 2010. To achieve this goal, WPA provides technical support and educational and outreach materials about utility-scale



development and small wind electric systems to utilities, rural cooperatives, federal property managers, rural landowners, Native Americans, and the public.

### Analysis and Industry Support

DOE's Wind Energy Program supports industry and federal and state agencies by publishing and distributing information about developing and deploying wind energy technology. Publications range from highly technical reports that target the engineering community to outreach publications geared to general audiences. The program also supports organizations such as NWCC and UWIG. Both organizations are run by industry, and they strive to help utilities and public organizations understand the value of wind energy and the barriers to deployment. The program's wind resource assessment efforts also contribute to industry support.

### Regional Field Verification

DOE Wind Energy Program researchers work closely with industry partners to research, develop, and verify advanced large and small wind turbine systems. These public-private partnerships include cost-shared research that leads to the development of prototype advanced wind turbines and field verification projects that prove the operational performance of the prototypes in a commercial environment.

The objectives of the Regional Field Verification Project are to:

- Support industry needs for gaining initial field operation experience with advanced technology wind turbines and verify the performance, reliability, maintainability, and cost of new wind turbines in a commercial environment
- Help expand opportunities for wind energy in new regions of the United States by tailoring projects to meet unique regional requirements
- Document and communicate the experience from these projects for the benefit of others in the wind power development community.

### Certification and Standards

International certification standards ensure that wind turbine designs are sound, safe, and

executed with good engineering practice. The sales of U.S. wind turbines depend heavily on their ability to meet international wind energy standards. Before 2000, U.S. industry was forced to conduct all their certification design evaluations and final certification approvals overseas. In 2000, NREL completed a certification quality system that supports design evaluation and certification approval through a partnership between Underwriters Laboratory (UL) and the certification team at the NWTC. Standards developed under the International Electrotechnical Commission (IEC) form the basis for this certification program. However, new standards are under development that will update or create new technical requirements and design techniques. NREL will work with industry to develop the new design techniques that support standards that meet the needs of U.S. manufacturers. Researchers at NREL and SNL serve on international standards committees, and NREL acts as the certification agency for the United States. ♦



NREL's 2.5 MW dynamometer is used to conduct a range of wind industry system tests that cannot be duplicated in the field.

## A Strong Energy Portfolio for a Strong America

Energy efficiency and clean, renewable energy will mean a stronger economy, a cleaner environment, and greater energy independence for America. By investing in technology breakthroughs today, our Nation can look forward to a more resilient economy and secure future.

Far-reaching technology changes will be essential to America's energy future. Working with a wide array of state, community, industry, and university partners, the U.S. Department of Energy's Office of Energy Efficiency and Renewable Energy invests in a portfolio of energy technologies that will:

- Conserve energy in the residential, commercial, industrial, government, and transportation sectors
- Increase and diversify energy supply, with a focus on renewable domestic sources
- Upgrade our National energy infrastructure
- Facilitate the emergence of hydrogen technologies as a vital new "energy carrier."

### Key Contacts

#### U.S. Department of Energy

Peter Goldman, Director  
Office of Wind and Hydropower Technologies  
Energy Efficiency and Renewable Energy  
1000 Independence Avenue, SW, Washington, DC 20585

#### National Renewable Energy Laboratory

Robert Thresher, Director  
National Wind Technology Center  
1617 Cole Boulevard, Golden, CO 80401

Brian Smith, Technology Manager  
Wind and Hydropower Technologies  
National Wind Technology Center  
1617 Cole Boulevard, Golden, CO 80401

#### Sandia National Laboratories

Paul Veers, Acting Wind Energy Technology  
Program Manager  
P.O. Box 5800, Albuquerque, NM 87185-0708

**NOTICE:** This report was prepared as an account of work sponsored by an agency of the United States government. Neither the United States government nor any agency thereof, nor any of their employees, makes any warranty, express or implied, or assumes any legal liability or responsibility for the accuracy, completeness, or usefulness of any information, apparatus, product, or process disclosed, or represents that its use would not infringe privately owned rights. Reference herein to any specific commercial product, process, or service by trade name, trademark, manufacturer, or otherwise does not necessarily constitute or imply its endorsement, recommendation, or favoring by the United States government or any agency thereof. The views and opinions of authors expressed herein do not necessarily state or reflect those of the United States government or any agency thereof.

Available electronically at [www.doe.gov/bridge](http://www.doe.gov/bridge)

Available for a processing fee to U.S. Department of Energy and its contractors, in paper, from:

U.S. Department of Energy  
Office of Scientific and Technical Information  
P.O. Box 62  
Oak Ridge, TN 37831-0062  
phone: 865.576.8401  
fax: 865.576.5728  
email: [reports@adonis.osti.gov](mailto:reports@adonis.osti.gov)

Available for sale to the public, in paper, from:

U.S. Department of Commerce  
National Technical Information Service  
5285 Port Royal Road  
Springfield, VA 22161  
phone: 800.553.6847  
fax: 703.605.6900  
email: [orders@ntis.fedworld.gov](mailto:orders@ntis.fedworld.gov)  
online ordering: [www.ntis.gov/ordering.htm](http://www.ntis.gov/ordering.htm)

#### Wind Energy Program Web Sites:

U.S. Department of Energy:  
[www.eere.energy.gov/wind](http://www.eere.energy.gov/wind)  
National Renewable Energy Laboratory:  
[www.nrel.gov/wind](http://www.nrel.gov/wind)  
Sandia National Laboratories:  
[www.sandia.gov/Renewable-Energy/wind-energy/homepage.html](http://www.sandia.gov/Renewable-Energy/wind-energy/homepage.html)  
Wind Powering America:  
[www.windpoweringamerica.gov](http://www.windpoweringamerica.gov)

**PHOTO CREDITS:** Cover Photo—Cover photos: GE Wind Energy/PIX number 12931; Sagrillo Power and Light/PIX 12966; GE Wind Energy/PIX 12932; NREL/11246; GE Wind Energy/PIX 12930; USDA/PIX 13174; Grant County, PUD, Washington/PIX 12487; Praxair, Inc./PIX 03978. Page 1: NREL/PIX10817; East River Electric/PIX 10637. Page 2: GE Wind Energy/PIX12933. Page 4: Todd Spink/PIX 11275; Atlantic Orient Corporation/PIX 01628; NREL/PIX10820; Northern Power Systems/PIX01629; U.S. Wind Power/PIX00054; NREL/PIX 11220. Page5: NREL/10012; EnronWind Corporation/PIX 07173; GE Wind Energy/PIX 12932; Sagrillo Power and Light/PIX 12966; NREL/PIX 00261. Page 6: GE Wind Energy/PIX 12424; Todd Spink/PIX 11283. Page 9: NREL/PIX 12893. Page 10: NREL/13173. Page 11: NREL/10016; Southwest Windpower; Bergery Windpower/PIX 12490; NREL/PIX 13175. Page 15: Larry Widdel/PIX 12550. Page 16: Waverly Light and Power/PIX 11511; GE Wind Energy/PIX 12930. Page 19: NREL/PIX 13161. Page 20: NREL/PIX 13043. Page 23: Hull Municipal Lighting Plant/PIX 11261. Page 25: NREL/PIX 08699. Page 27: U.S. Department of Energy, INEL/PIX 12486; GE Wind Energy/PIX 12335. Page 28: NREL/PIX 11148. Page 29: Sandia National Laboratories/PIX 11071; NREL/PIX 09996. Page 30: NREL/PIX 12415. Page 32: NREL/PIX 11061. Page 33: NREL/PIX 08580.

Produced for the



U.S. Department of Energy  
**Energy Efficiency  
and Renewable Energy**

1000 Independence Avenue, SW, Washington, DC 20585

By the National Renewable Energy Laboratory,  
a DOE National laboratory

DOE/GO-102004-1894

March 2004

Printed with renewable-source ink on paper containing at least  
50% wastepaper, including 20% postconsumer waste